

Cilindros Neumáticos

Contamos con una completa gama de cilindros neumáticos:

- ISO 15552 (Milimétricos)
- ISO 21287 (Compactos)
- Twin (Compactos doble vástago)
- ISO 6432 (Redondos milimétricos)
- Redondos Inox. (En pulgadas)
- Cilindros sin vástago
- Pinzas neumáticas
- Mesas rotativas
- De freno
- Posicionadores
- Prensas neumáticas

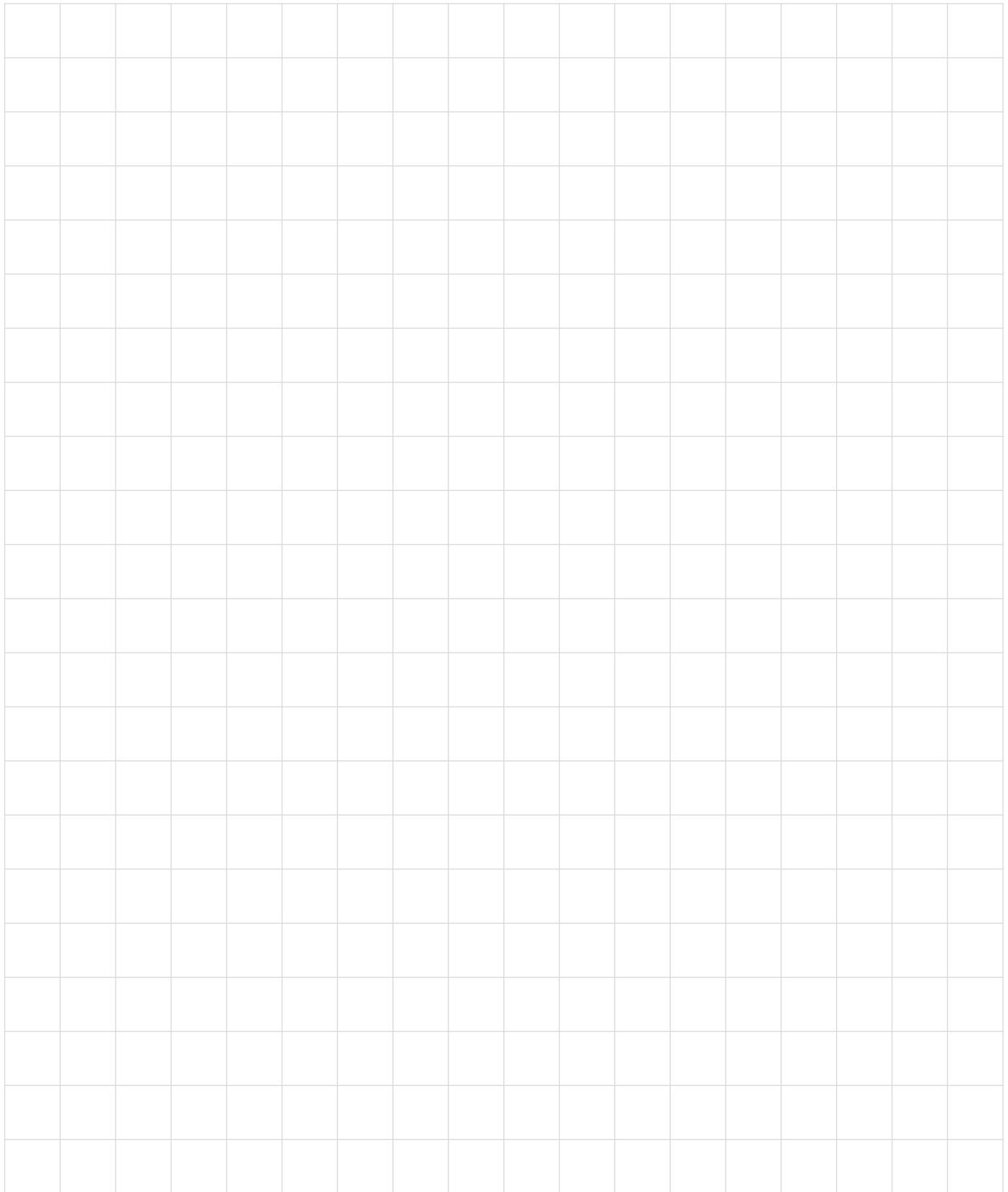



Cilindros Norma ISO 15552

Cilindros Norma ISO 15552 Serie CA	Cilindros-09
Montajes y Accesorios	Cilindros-10
Sensores Magnéticos	Cilindros-10



Guías Antigiro

Guías Antigiro Serie CAGB	Cilindros-14
----------------------------------	------------------------------



Cilindros Compactos ISO 21287

Cilindros Compactos ISO 21287 Serie CCI	Cilindros-16
Montajes y Accesorios	Cilindros-17
Sensores Magnéticos	Cilindros-17



Cilindros Compactos

Cilindros Compactos Serie CC	Cilindros-22
Sensores Magnéticos	Cilindros-23



Cilindros Twin

Cilindros Twin Serie CT	Cilindros-24
Sensores Magnéticos	Cilindros-24



Cilindros Especiales

Cilindros TRI-ROD **Serie CTR** [Cilindros-26](#)

Cilindros Compactos Mesa Deslizante **Serie CCD** [Cilindros-28](#)



Cilindros En Acero Inoxidable ISO 6432

Cilindros ISO 6432 **Serie CI** [Cilindros-30](#)

Cilindros ISO 6432 Amortiguados **Serie CIA** [Cilindros-31](#)

Montajes y Accesorios [Cilindros-32](#)

Sensores Magnéticos [Cilindros-32](#)



Cilindros En Acero Inoxidable En Pulgadas

Cilindros Inoxidables En Pulgadas **Serie CIP** [Cilindros-36](#)

Montajes y Accesorios [Cilindros-37](#)



Cilindros Clamp

Cilindros Clamp **Serie CCL** [Cilindros-40](#)

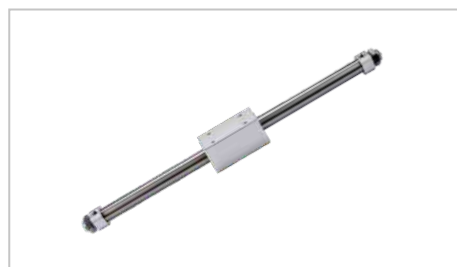

Cilindros Sin Vástago - Magnéticos

Cilindros Sin Vástago **Serie RMS** [Cilindros-42](#)

Montajes y Accesorios [Cilindros-43](#)



Cilindros Sin Vástago - Magnéticos con Guía

Cilindros Sin Vástago **Serie RMT** [Cilindros-45](#)

Montajes y Accesorios [Cilindros-46](#)



Pinzas Neumáticas

Pinzas Angulares **Serie CPA** [Cilindros-48](#)

Pinzas Paralelas **Serie CPP** [Cilindros-50](#)

Pinzas Angulares 180° **Serie CPO** [Cilindros-52](#)



Mesas Rotativas

Mesas Rotativas **Serie CRM** [Cilindros-54](#)



Cilindros De Freno

Cilindros De Freno **Serie CF** [Cilindros-56](#)



Tanque Hidro-Neumático

Tanque Hidro-Neumático **Serie CCH** [Cilindros-58](#)



Multiplicador de Presión P/Cilindro Hidráulico

Multiplicador de Presión Hidráulico **Serie CMH** [Cilindros-59](#)



Multiplicadores de Presión

Multiplicadores de Presión **Serie CMP** [Cilindros-60](#)



Cilindro Posicionador Lineal

Cilindro Posicionador Lineal **Serie CP** [Cilindros-61](#)



Prensas Neumáticas

Prensas Neumáticas

Serie PN (1/4", 3/8") [Cilindros-63](#)

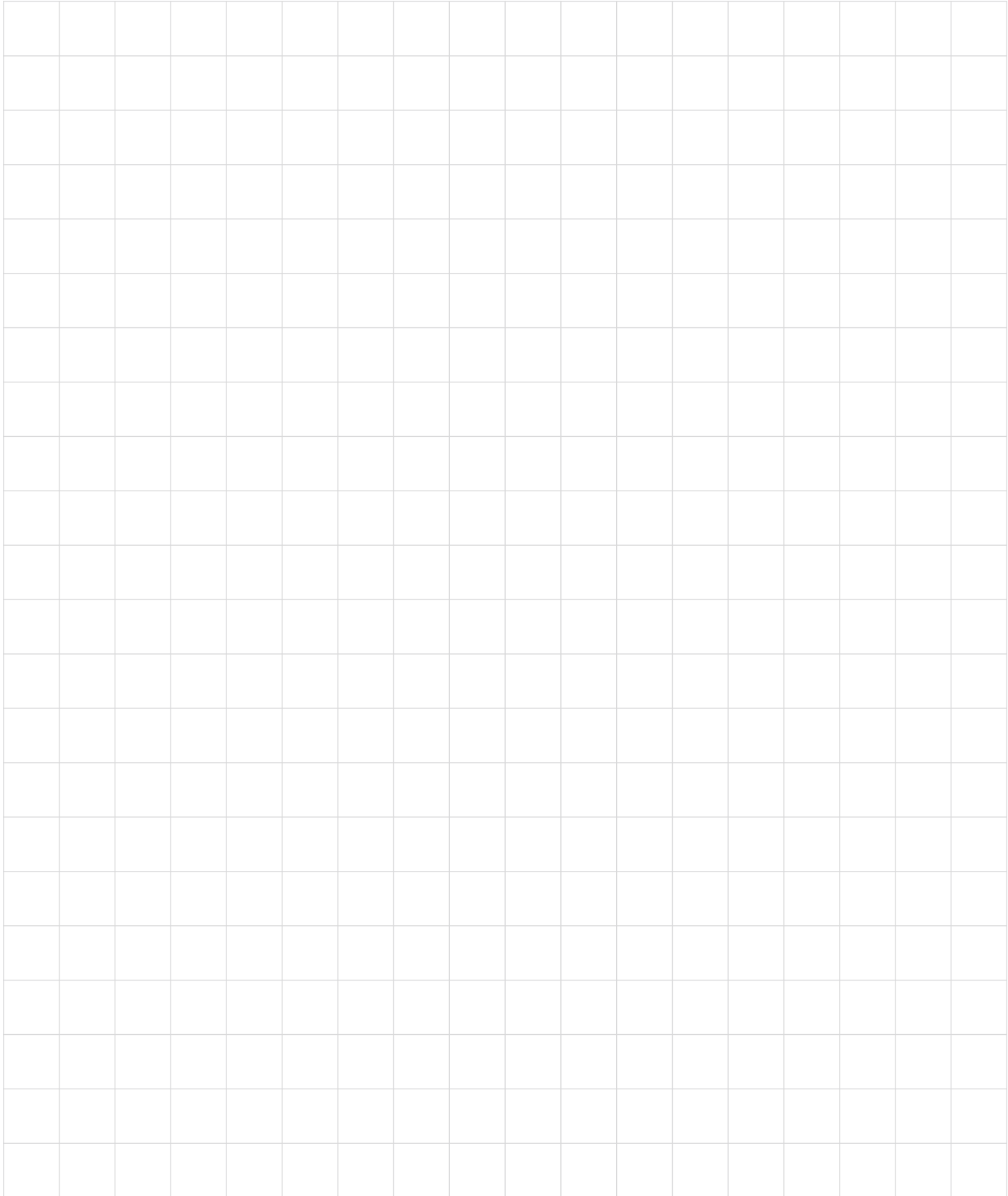

Cilindros Standar ISO 15552

Diámetros (mm)

- 32, 40, 50, 63, 80
- 100, 125, 160, 200

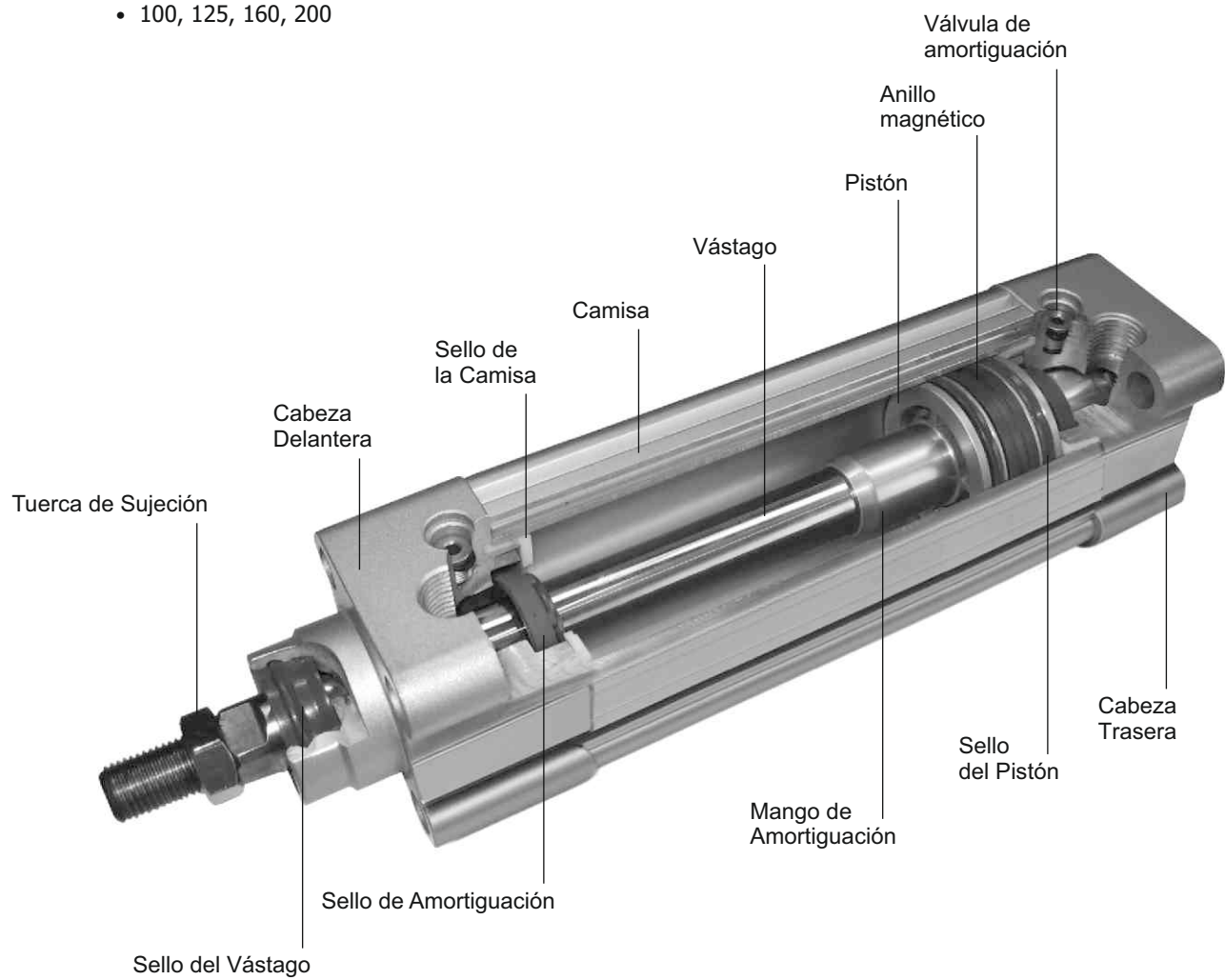

CILINDROS NORMAS ISO 15552 / ISO 6431 / VDMA 24562

SERIE CA

Ar.t

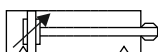

Características

- Normas: ISO 15552
ISO 6431
VDMA 24562
- Modelos con embolo magnético para control de posición
- Los interruptores magnéticos quedan integrados en el perfil de la camisa
- Los cilindros de 160 y 200 mm poseen sensores ocultos
- Amortiguación regulable en ambas cabezas
- No requieren lubricación

Modelos Standard

Datos Técnicos

Fluido:
Aire comprimido Filtrado,
lubricado o no lubricado

Presión de Trabajo:
1,5 a 10 Bar ~ 22 a 145 PSI

Temperatura de Trabajo:
20°C a 70°C

Kit de Alta Temperatura:
Hasta 150°C ~ 302°F

Amortiguación:
Neumática, Regulable

Materiales

Perfil:
Aluminio inyectado



Cabezas:
Aluminio inyectado



Vástago:
Acero al carbón con 20µ de
superficie cromo-endurecida
Opcional: Acero Inoxidable

Empaques:
TPU (Poliuretano Termoplástico)
NBR

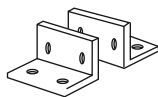
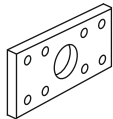
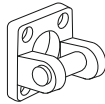
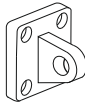
Carrera mm (Pulg)	Diámetro del cilindro en milímetros								
	32	40	50	63	80	100	125	160	200
25 (1")	CA32025	CA40025	CA50025	CA63025	CA80025	CA100025	CA125025X	CA160025X	CA200025X
50 (2")	CA32050	CA40050	CA50050	CA63050	CA80050	CA100050	CA125050X	CA160050X	CA200050X
75 (3")	CA32075	CA40075	CA50075	CA63075	CA80075	CA100075	CA125075X	CA160075X	CA200075X
80 (3,1/4")	CA32080	CA40080	CA50080	CA63080	CA80080	CA100080	CA125080X	CA160080X	CA200080X
100 (4")	CA32100	CA40100	CA50100	CA63100	CA80100	CA100100	CA125100X	CA160100X	CA200100X
125 (5")	CA32125	CA40125	CA50125	CA63125	CA80125	CA100125	CA125125X	CA160125X	CA200125X
150 (6")	CA32150	CA40150	CA50150	CA63150	CA80150	CA100150	CA125150X	CA160150X	CA200150X
175 (7")	CA32175	CA40175	CA50175	CA63175	CA80175	CA100175	CA125175X	CA160175X	CA200175X
200 (8")	CA32200	CA40200	CA50200	CA63200	CA80200	CA100200	CA125200X	CA160200X	CA200200X
250 (10")	CA32250	CA40250	CA50250	CA63250	CA80250	CA100250	CA125250X	CA160250X	CA200250X
300 (12")	CA32300	CA40300	CA50300	CA63300	CA80300	CA100300	CA125300X	CA160300X	CA200300X
350 (14")	CA32350	CA40350	CA50350	CA63350	CA80350	CA100350	CA125350X	CA160350X	CA200350X
400 (16")	CA32400	CA40400	CA50400	CA63400	CA80400	CA100400	CA125400X	CA160400X	CA200400X
450 (18")	CA32450	CA40450	CA50450	CA63450	CA80450	CA100450	CA125450X	CA160450X	CA200450X
500 (20")	CA32500	CA40500	CA50500	CA63500	CA80500	CA100500	CA125500X	CA160500X	CA200500X
600 (24")	CA32600	CA40600	CA50600	CA63600	CA80600	CA100600	CA125600X	CA160600X	CA200600X
700 (28")	CA32700	CA40700	CA50700	CA63700	CA80700	CA100700	CA125700X	CA160700X	CA200700X
800 (32")	CA32800	CA40800	CA50800	CA63800	CA80800	CA100800	CA125800X	CA160800X	CA200800X
900 (36")	CA32900	CA40900	CA50900	CA63900	CA80900	CA100900	CA125900X	CA160900X	CA200900X
1000 (40")	CA321000	CA401000	CA501000	CA631000	CA801000	CA1001000	CA1251000X	CA1601000X	CA2001000X
1100 (44")							CA1251100X	CA1601100X	CA2001100X
1200 (48")							CA1251200X	CA1601200X	CA2001200X
1300 (52")							CA1251300X	CA1601300X	CA2001300X
1400 (56")							CA1251400X	CA1601400X	CA2001400X
1500 (60")							CA1251500X	CA1601500X	CA2001500X
Ø Vástago	12 mm	16 mm	20 mm	20 mm	25 mm	25 mm	32 mm	40 mm	40 mm
Conexión	G1/8	G1/4	G1/4	G3/8	G3/8	G1/2	G1/2	G3/4	G3/4
Empaques	CAK032	CAK040	CAK050	CAK063	CAK080	CAK100	CAK125	CAK160	CAK200
Alta Temp.	CACT032	CACT040	CACT050	CACT063	CACT080	CACT100	CACT125		

* Para carreras no standard y cilindros de doble vástago consulte con su distribuidor

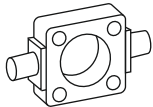
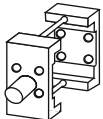
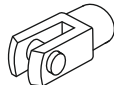
Ø	CAP - Pies	CAF - Flanche	CAPP - Pivote Hembra	CAPM - Pivote Macho	CASM - Soporte Macho
					
Ø	Referencia	Referencia	Referencia	Referencia	Referencia
32	CAP032	CAF032	CAPP032	CAPM032	CASM032
40	CAP040	CAF040	CAPP040	CAPM040	CASM040
50	CAP050	CAF050	CAPP050	CAPM050	CASM050
63	CAP063	CAF063	CAPP063	CAPM063	CASM063
80	CAP080	CAF080	CAPP080	CAPM080	CASM080
100	CAP100	CAF100	CAPP100	CAPM100	CASM100
125	CAP125	CAF125	CAPP125	CAPM125	CASM125
160	CAP160	CAF160	CAPP160	CAPM160	CASM160
200	CAP200	CAF200	CAPP200	CAPM200	CASM200

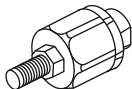
Ø	CAB - Balancín Frontal	CABC - Balancin Central	CAH - Horquilla	CAR - Rotula	CAU - Autoalineador
					
Ø	Referencia	Referencia	Referencia	Referencia	Referencia
32	CAB032	CABC032	CAH032	CAR032	CAU032
40	CAB040	CABC040	CAH040	CAR040	CAU040
50	CAB050	CABC050	CAH063	CAR063	CAU063
63	CAB063	CABC063	CAH063	CAR063	CAU063
80	CAB080	CABC080	CAH100	CAR100	CAU100
100	CAB100	CABC100	CAH100	CAR100	CAU100
125	CAB125	CABC125	CAH125		
160	CAB160		CAH160		
200	CAB200		CAH160		



Autoswitch Magnético
CASS01
Tipo Red Switch (2 hilos)



Autoswitch Universal
CANSS01
Se puede utilizar en Cilindros:
NORGREN, FESTO,
PARKER, SMC

Descripción	Autoswitch Magnéticos
	CASS01 / CANSS01
Contacto	Normalmente abierto
Indicador	LED Superior
Temperatura	0 a 60 °C ~ 32 a 140 °F
Protección	IP 64
Rango de voltaje	5 ~ 240V AC / DC
Rango de corriente	5 ~ 100 mA
Resistencia a la vibración	10 ~ 50 Hz
Tiempo de respuesta	5 ms
Longitud de Cable	2 Mts.
Usar con cilindros	32 ~ 200 mm

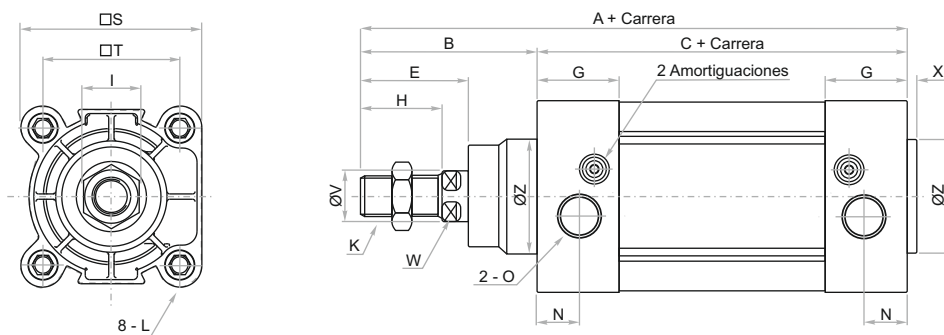

Diámetro	A	B	C	E	G	H	I	K	L
32 mm	142	48	94	29	27.5	22	17	M10 x 1.25	M6
40 mm	159	54	105	33	32	24	17	M12 x 1.25	M6
50 mm	175	69	106	42	31	32	23	M16 x 1.5	M8
63 mm	190	69	121	42	33	32	23	M16 x 1.5	M8
80 mm	214	86	128	53	33	40	26	M20 x 1.5	M10
100 mm	229	91	138	55	37	40	26	M20 x 1.5	M10
125 mm	279	119	160	74	46	54	41	M27 x 2	M12
160 mm	332	152	180	94	50	72	55	M36 x 2	M16
200 mm	347	167	180	100	50	72	55	M36 x 2	M16

Diámetro	N	O	S	T	ØV	W	X	ØZ
32 mm	13	1/8	47	32,5	12	10	3	30
40 mm	17	1/4	53	38	16	13	3,5	35
50 mm	15,5	1/4	65	46,5	20	17	3,5	40
63 mm	16,5	3/8	75	56,5	20	17	4	45
80 mm	16,5	3/8	95	72	25	22	4	45
100 mm	18,5	1/2	115	89	25	22	4	55
125 mm	23	1/2	140	110	32	27	4	60
160 mm	25	3/4	180	140	40	36	4	65
200 mm	25	3/4	220	175	40	36	5	75

Cilindros Doble Vástago

Diámetro	A	C
32 mm	190	94
40 mm	213	105
50 mm	244	106
63 mm	259	121
80 mm	300	128
100 mm	320	138
125 mm	398	160
160 mm	484	180
200 mm	514	180

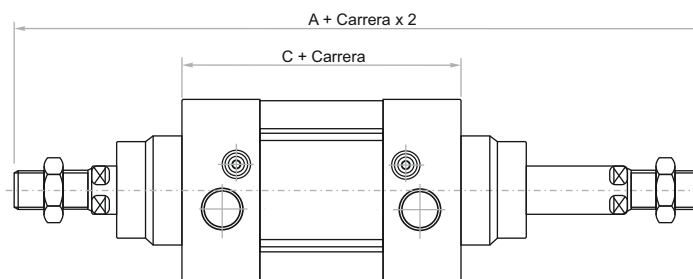

Pies

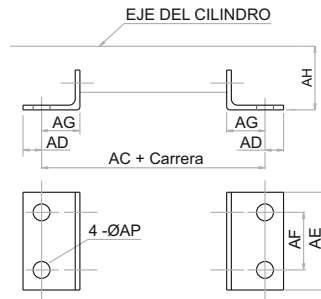

Diam.	AC	AD	AE	AF	AG	AH	ØAP
32	142	8	47	32	24	32	7
40	161	9	53	36	28	36	9
50	170	10	65	45	32	45	9
63	185	12	75	50	32	50	9
80	210	19	95	63	41	63	12,5
100	220	19	115	75	45	71	14,5
125	250	20	140	90	45	90	16,5
160	300	20	180	115	60	115	18,5
200	320	30	220	135	70	135	24

Flanche

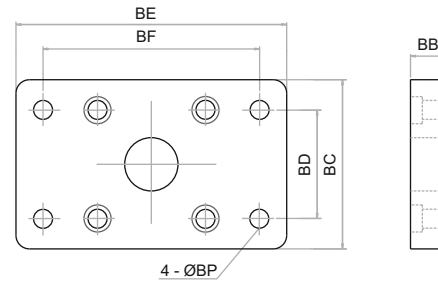

Diam.	BB	BC	BD	BE	BF	ØBP
32	10	47	32	80	64	7
40	10	53	36	90	72	9
50	12	65	45	108	90	9
63	12	75	50	118	100	9
80	16	95	63	150	126	12,5
100	16	115	75	176	150	14,5
125	20	139	90	218	180	16,5
160	20	180	115	280	230	18,5
200	25	220	135	320	270	24

Pivote Hembra

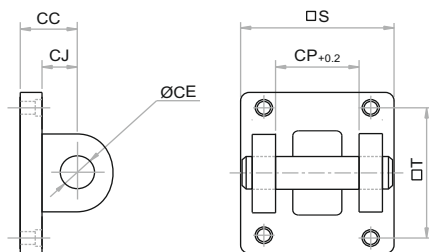

Diam.	CC	ØCE	CJ	CP	T	S
32	22	10	13	26	32,5	47
40	25	12	16	28	38	52
50	27	12	17	32	46,5	64
63	32	16	22	40	56,5	74
80	36	16	22	50	72	94
100	41	20	27	60	89	113
125	50	25	33	70	110	139
160	55	30	35,5	90	140	180
200	60	30	36	90	175	220

Pivote Macho

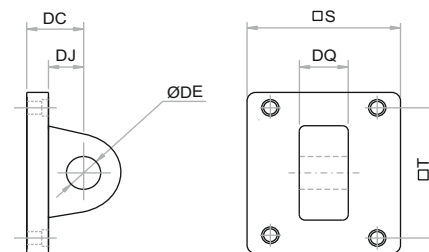

Diam.	DC	ØDE	DJ	DQ	T	S
32	22	10	13	25,8	32,5	47
40	25	12	16	27,8	38	52
50	27	12	17	31,7	46,5	64
63	32	16	22	39,7	56,5	74
80	36	16	22	49,7	72	94
100	41	20	27	59,7	89	113
125	50	25	33	69,7	110	139
160	55	30	35,5	89,7	140	180
200	60	30	37	89,7	175	220

Soporte Macho

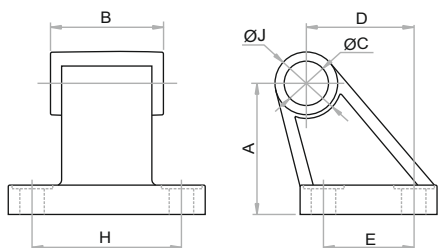

Diam.	A	B	ØC	D	E	H	ØJ
32	32	26	10	21	18	38	20
40	36	28	12	24	22	41	22
50	45	32	12	33	30	50	26
63	50	40	16	37	35	52	30
80	63	50	16	47	40	66	30
100	71	60	20	55	50	76	38
125	90	70	25	70	60	94	45
160	115	90	30	97	88	118	63
200	135	90	30	105	90	122	63

Balancín Frontal

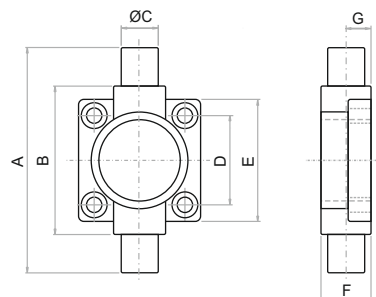

Diam.	A	B	ØC	D	E	F	G
32	74	50	12	32.5	46	19	10
40	95	63	16	38	52	21	10
50	107	75	16	46.5	64	26	12
63	130	90	20	56.5	74	28	12
80	150	110	20	72	94	31	16
100	182	132	25	89	114	35	16
125	210	160	25	110	139	43	20
160	264	200	32	140	179	56	20
200	314	250	32	175	218	64	20

Horquilla

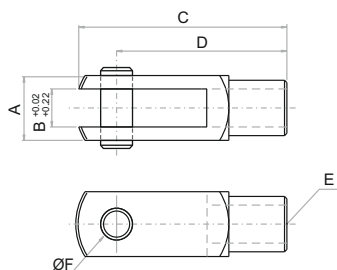

Diam.	A	B	C	D	E	F
32	19	10	52	40	M 10 x 1,25	10
40	25,4	12	62	48	M 12 x 1,25	12
50 ~ 63	32	16	80	64	M 16 x 1,5	16
80 ~ 100	44,4	20	101	80	M 20 x 1,5	20
125	54	30	139	110	M 27 x 2	30
160 ~ 200	70	35	179	144	M 36 x 2	35

Rótula

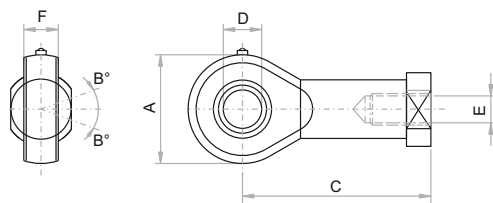

Diam.	A	B°	C	D	E	F
32	26	13°	43	10	M 10 x 1,25	11
40	32	13°	50	12	M 12 x 1,25	12
50 ~ 63	40	15°	64	16	M 16 x 1,5	15
80 ~ 100	46	15°	77	20	M 20 x 1,5	18

Autoalineador

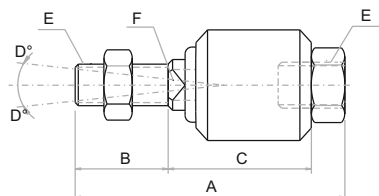

Diam.	A	B	C	D°	E	F
32	58	22	21	12°	M 10 x 1,25	10
40	58	22	21	12°	M 12 x 1,25	12
50 ~ 63	90	27	41	7°	M 16 x 1,5	17
80 ~ 100	102	29	46	10°	M 20 x 1,5	22

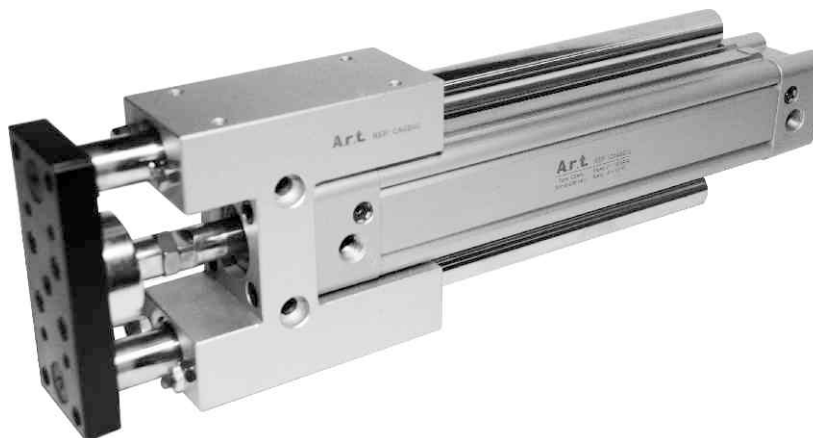

Características

- Esta doble guía ofrece un sistema compacto para que el movimiento de los nuevos cilindros Standard ISO 15552 sea siempre recto y sin giros.
- Esta guía esta montada sobre bujes de bronce, que permiten soportar grandes torques y cargas laterales.
- las guías traen un soporte para el sensor eléctrico, de acuerdo al diámetro del cilindro.
- Instalación y fijación multi direccional.
- El cilindro y la guía se unen por un autoalineador que evita la fricción.

Datos Técnicos

Temperatura de Trabajo:
-20°C a 70°C ~ 4°F a 158°F

Velocidad:
30 ~ 500 mm/seg

No requieren lubricación

Materiales

Cuerpo:
Aluminio

Guías:
Barra de Acero

Como solicitar su guía antigiro

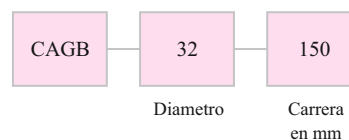

32	Ø del cilindro 32 mm
40	Ø del cilindro 40 mm
50	Ø del cilindro 50 mm
63	Ø del cilindro 63 mm

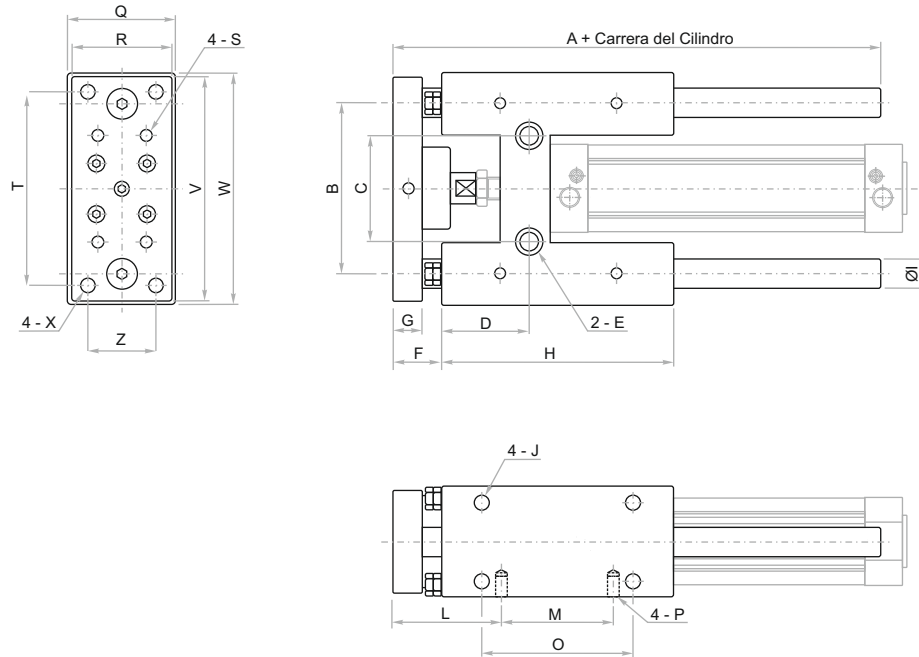

Diámetro	A	B	C	D	ØE	F	G	H
32 mm	164	85	48	55	8.5	18	12	125
40 mm	183,5	91	54	61	8.5	16	12	140
50 mm	198,5	108	66	72	10.5	18	15	150
63 mm	214	123	79	72	10.5	18	15	182

Diámetro	J	L	M	O	P	Q	R
32 mm	M6 x 1.0	55	32,5	40,2	M6 x 1.0	50	45
40 mm	M6 x 1.0	61	38	51	M6 x 1.0	58	54
50 mm	M8 x 1.25	72	46,5	64,7	M8 x 1.25	70	63
63 mm	M8 x 1.25	72	56,5	76,5	M8 x 1.25	85	80

Diámetro	S	T	V	W	X	ØI	Z
32 mm	M6 x 1.0	78	109	117	M6 x 1.0	20 (16)	32,5
40 mm	M6 x 1.0	84	115	123	M6 x 1.0	20 (16)	38
50 mm	M8 x 1.25	100	135	145	M8x 1.25	20	46,5
63 mm	M8 x 1.25	105	150	160	M8 x 1.25	20	56,5



Doble efecto

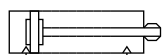

Simple efecto

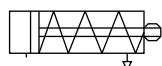

Características

- Especiales para espacios reducidos
- Fabricados en Aluminio
- Modelos con embolo magnético para control de posición
- Los interruptores magnéticos quedan integrados en el perfil
- Vástago con rosca hembra
- No requieren lubricación

Datos Técnicos

Fluido:

Aire comprimido Filtrado, lubricado o no lubricado

Presión de Trabajo:

1 a 10 Bar ~ 14,5 a 145 PSI

Temperatura de Trabajo:

-20°C a 80°C ~ -4°F a 176°F

Amortiguación:

Elástica

Materiales

Perfil:

Aluminio inyectado

Cabezas:

Aluminio inyectado

Vástago:

Cilindros Ø 12, 16, 20, 25 mm
Acero inoxidable

Vástago:

Cilindros Ø 32 ~ 100 mm
Acero al carbón con 20µ de superficie cromo-endurecida

Empaques:

TPU / NBR

Modelos Standard

Carrera	Diámetro del cilindro en milímetros									
	12	16	20	25	32	40	50	63	80	100
5 mm	CCI12005	CCI16005	CCI20005	CCI25005	CCI32005	CCI40005	CCI50005	CCI63005	CCI80005	CCI100005
10 mm	CCI12010	CCI16010	CCI20010	CCI25010	CCI32010	CCI40010	CCI50010	CCI63010	CCI80010	CCI100010
15 mm	CCI12015	CCI16015	CCI20015	CCI25015	CCI32015	CCI40015	CCI50015	CCI63015	CCI80015	CCI100015
20 mm	CCI12020	CCI16020	CCI20020	CCI25020	CCI32020	CCI40020	CCI50020	CCI63020	CCI80020	CCI100020
25 mm	CCI12025	CCI16025	CCI20025	CCI25025	CCI32025	CCI40025	CCI50025	CCI63025	CCI80025	CCI100025
30 mm	CCI12030	CCI16030	CCI20030	CCI25030	CCI32030	CCI40030	CCI50030	CCI63030	CCI80030	CCI100030
35 mm	CCI12035	CCI16035	CCI20035	CCI25035	CCI32035	CCI40035	CCI50035	CCI63035	CCI80035	CCI100035
40 mm	CCI12040	CCI16040	CCI20040	CCI25040	CCI32040	CCI40040	CCI50040	CCI63040	CCI80040	CCI100040
45 mm	CCI12045	CCI16045	CCI20045	CCI25045	CCI32045	CCI40045	CCI50045	CCI63045	CCI80045	CCI100045
50 mm	CCI12050	CCI16050	CCI20050	CCI25050	CCI32050	CCI40050	CCI50050	CCI63050	CCI80050	CCI100050
60 mm		CCI16060	CCI20060	CCI25060	CCI32060	CCI40060	CCI50060	CCI63060	CCI80060	CCI100060
70 mm		CCI16070	CCI20070	CCI25070	CCI32070	CCI40070	CCI50070	CCI63070	CCI80070	CCI100070
75 mm		CCI16075	CCI20075	CCI25075	CCI32075	CCI40075	CCI50075	CCI63075	CCI80075	CCI100075
80 mm			CCI20080	CCI25080	CCI32080	CCI40080	CCI50080	CCI63080	CCI80080	CCI100080
90 mm			CCI20090	CCI25090	CCI32090	CCI40090	CCI50090	CCI63090	CCI80090	CCI100090
100 mm			CCI20100	CCI25100	CCI32100	CCI40100	CCI50100	CCI63100	CCI80100	CCI100100
110 mm				CCI25110	CCI32110	CCI40110	CCI50110	CCI63110	CCI80110	CCI100110
120 mm				CCI25120	CCI32120	CCI40120	CCI50120	CCI63120	CCI80120	CCI100120
125 mm				CCI25125	CCI32125	CCI40125	CCI50125	CCI63125	CCI80125	CCI100125
150 mm				CCI25150	CCI32150	CCI40150	CCI50150	CCI63150	CCI80150	CCI100150
160 mm					CCI32160	CCI40160	CCI50160	CCI63160	CCI80160	CCI100160
175 mm					CCI32175	CCI40175	CCI50175	CCI63175	CCI80175	CCI100175
200 mm					CCI32200	CCI40200	CCI50200	CCI63200	CCI80200	CCI100200
225 mm							CCI50225	CCI63225	CCI80225	CCI100225
250 mm							CCI50250	CCI63250	CCI80250	CCI100250
275 mm									CCI80275	CCI100275
300 mm									CCI80300	CCI100300
Ø Vástago	6 mm	8 mm	10 mm	10 mm	12 mm	12 mm	16 mm	16 mm	20 mm	20 mm
Conexión	M5	M5	M5	M5	1/8"	1/8"	1/8"	1/8"	1/8"	1/8"
Empaques	CCIK012	CCIK016	CCIK020	CCIK025	CCIK032	CCIK040	CCIK050	CCIK063	CCIK080	CCIK100



* Para carreras no standard, cilindros de simple efecto y doble vástago consulte con su distribuidor

CILINDROS COMPACTOS NORMA ISO 21287

MONTAJES

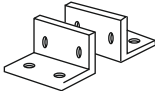
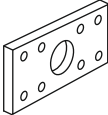
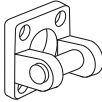
Art

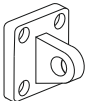
Ø	CAP - Pies	CAF - Flanche	CAPP - Pivote Hembra
			
Ø	Referencia	Referencia	Referencia
12	CAP012	CAF012	
16	CAP016	CAF016	
20	CAP020	CAF020	
25	CAP025	CAF025	
32	CAP032	CAF032	CAPP032
40	CAP040	CAF040	CAPP040
50	CAP050	CAF050	CAPP050
63	CAP063	CAF063	CAPP063
80	CAP080	CAF080	CAPP080
100	CAP100	CAF100	CAPP100

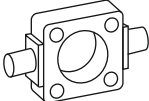
Ø	CAPM - Pivote Macho	CASM - Soporte Macho	CAB - Balancín Frontal
			
Ø	Referencia	Referencia	Referencia
12	CAPM012		
16	CAPM016		
20	CAPM020		
25	CAPM025		
32	CAPM032	CASM032	CAB032
40	CAPM040	CASM040	CAB040
50	CAPM050	CASM050	CAB050
63	CAPM063	CASM063	CAB063
80	CAPM080	CASM080	CAB080
100	CAPM100	CASM100	CAB100



Sensores Magnéticos

CASS01

Tipo Red Switch (2 hilos)

Descripción	Sensor Magnético
	CASS01
Contacto	Normalmente abierto
Indicador	LED Superior
Temperatura	0 a 60 °C ~ 32 a 140 °F
Protección	IP 64
Rango de voltaje	5 ~ 240V AC / DC
Rango de corriente	5 ~ 100 mA
Resistencia a la vibración	10 ~ 50 Hz
Tiempo de respuesta	5 ms
Longitud de Cable	2 Mts.

Cilindros de Simple y Doble Efecto

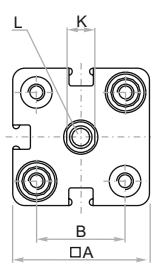

Ø12 ~ Ø25 mm

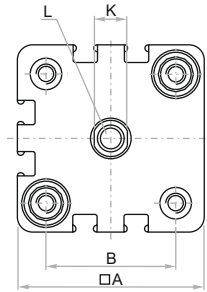

Ø32 ~ Ø100 mm

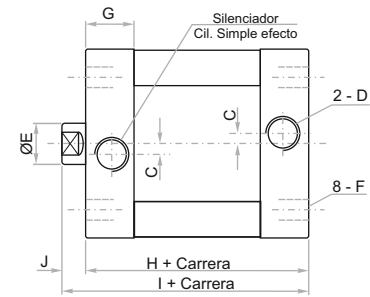

Diámetro	A	B	C	D	E	F
12 mm	27,5	16	2	M5 x 0,8	6	M4 x 0,7
16 mm	30	18	2	M5 x 0,8	8	M4 x 0,7
20 mm	35,5	22	2	M5 x 0,8	10	M5 x 0,8
25 mm	40	26	2	M5 x 0,8	10	M5 x 0,8
32 mm	49,5	32,5	3	1/8"	12	M6 x 1,0
40 mm	55	38	3	1/8"	12	M6 x 1,0
50 mm	65,5	46,5	3	1/8"	16	M8 x 1,25
63 mm	75,5	56,5	4	1/8"	16	M8 x 1,25
80 mm	95,5	72	6	1/8"	20	M10 x 1,5
100 mm	113,5	89	7	1/8"	20	M10 x 1,5

Diámetro	G	H	I	J	K	L
12 mm	10	35	40	5	5	M3 x 0,5
16 mm	10	35	40	5	7	M4 x 0,7
20 mm	10,5	37	43	6	9	M6 x 1,0
25 mm	11	39	45	6	9	M6 x 1,0
32 mm	14	44	51	7	10	M8 x 1,25
40 mm	14,5	45,5	52,5	7	10	M8 x 1,25
50 mm	14,5	45,5	53,5	8	13	M10 x 1,5
63 mm	15	49	57	8	13	M10 x 1,5
80 mm	16	54	63	9	17	M12 x 1,75
100 mm	19	67	76	9	17	M12 x 1,75

Cilindros Doble Vástago

Diámetro	H	J	I
12 mm	35	5	45
16 mm	35	5	45
20 mm	37	6	49
25 mm	39	6	51
32 mm	44	7	58
40 mm	45,5	7	59,5
50 mm	45,5	8	61,5
63 mm	49	8	65
80 mm	54	9	72
100 mm	67	9	85

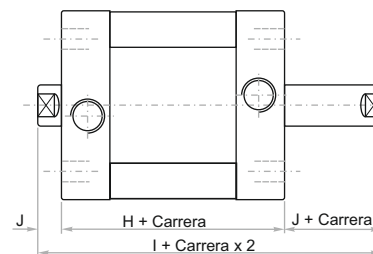

Pies

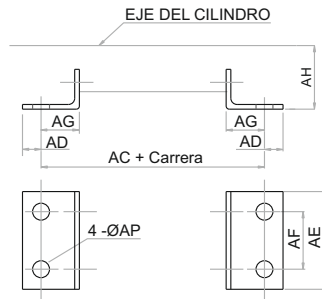

Diam.	AC	AD	AE	AF	AG	AH	ØAP
12	61	5	25	16	13	21	5,5
16	61	4,8	27	18	13	22	5,5
20	69	6,3	34	22	16	27	6,5
25	71	6,3	38	26	16	29	6,5
32	76	8	47	32	24	33,5	7
40	81,5	9	53	36	28	38	10
50	87,5	10	65	45	32	45	10
63	91	12	75	50	32	50	10
80	106	19	95	63	41	63	12
100	121	19	115	75	45	74	14,5

Flanche

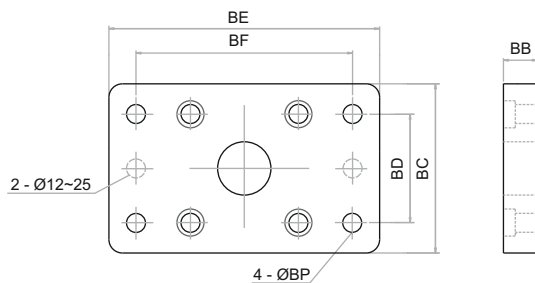

Diam.	BB	BC	BD	BE	BF	ØBP
12	8	25	-	55	40	5,5
16	8	30	-	55	43	5,5
20	8	35	-	68	55	6,6
25	8	39,5	-	76	60	6,6
32	10	47	32	80	64	7
40	10	53	36	90	72	9
50	12	65	45	108	90	9
63	12	75	50	118	100	9
80	16	95	63	150	126	12,5
100	16	115	75	176	150	14,5

Pivote Hembra

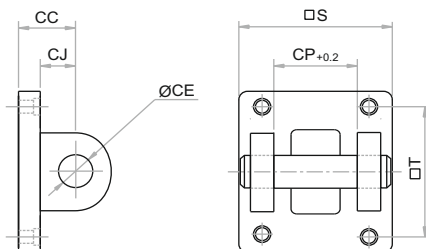

Diam.	CC	ØCE	CJ	CP	T	S
32	22	10	13	26	32,5	46,5
40	25	12	16	28	38	54
50	27	12	17	32	46,5	64
63	32	16	22	40	56,5	75
80	36	16	22	50	72	93
100	41	20	27	60	89	110

Pivote Macho

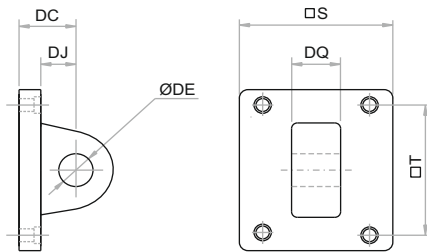

Diam.	DC	ØDE	DJ	DQ	T	S
12	16	6	7	11,9	16	24
16	16	6	7	11,9	18	28,5
20	20	8	11	15,9	22	34,5
25	20	8	11	15,9	26	38,5
32	22	10	13	25,8	32,5	46,5
40	25	12	16	27,8	38	54
50	27	12	17	31,7	46,5	64
63	32	16	22	39,7	56,5	75
80	36	16	22	49,7	72	93
100	41	20	27	59,7	89	110

Soporte Macho

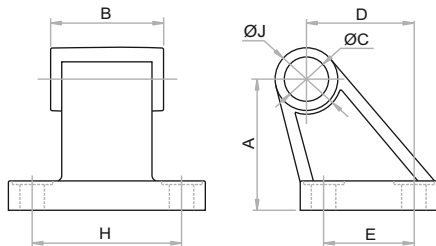

Diam.	A	B	ØC	D	E	H	ØJ
32	32	26	10	21	18	38	20
40	36	28	12	24	22	41	22
50	45	32	12	33	30	50	26
63	50	40	16	37	35	52	30
80	63	50	16	47	40	66	30
100	71	60	20	55	50	76	38

Balancín Frontal

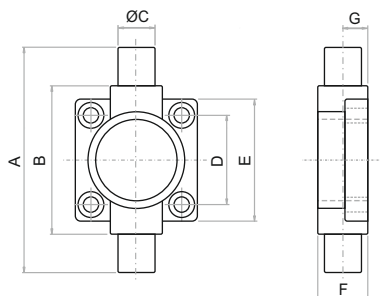

Diam.	A	B	ØC	D	E	F	G
32	74	50	12	32,5	46	19	10
40	95	63	16	38	52	21	10
50	107	75	16	46,5	64	26	12
63	130	90	20	56,5	74	28	12
80	150	110	20	72	94	31	16
100	182	132	25	89	114	35	16

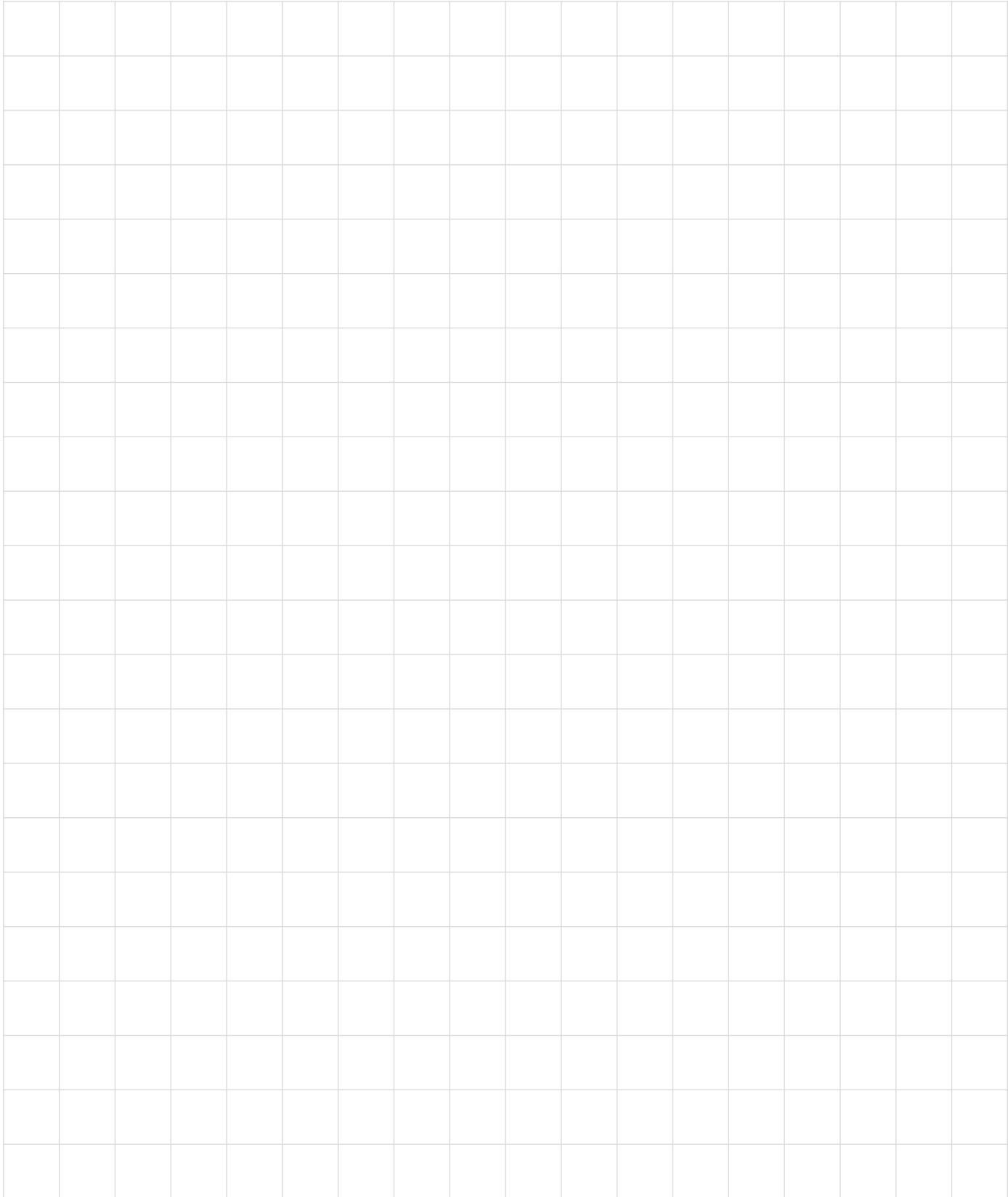

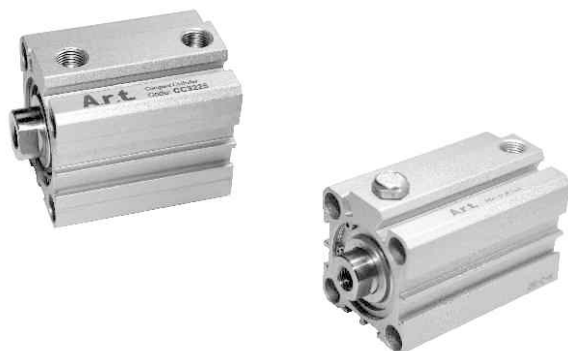

Características

- Especiales para espacios reducidos
- Fabricados en Aluminio
- Modelos con embolo magnético para control de posición
- Vástago con rosca hembra
- No requieren lubricación

Doble efecto

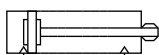

Simple efecto

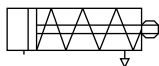

Datos Técnicos

Fluido:

Aire comprimido Filtrado,
lubricado o no lubricado

Presión de Trabajo:

Doble efecto:

1 a 10 Bar ~ 22 a 145 PSI

Simple efecto:

2 a 10 Bar ~ 28 a 145 PSI

Temperatura de Trabajo:

-5°C a 70°C ~ 23°F a 158°F

Amortiguación:

Elástica

Materiales

Cuerpo:

Aleación de Aluminio

Vástago:

Acero al carbón con 20µ de
superficie cromo-endurecida

Empaques:

Goma nitrílica

Modelos Standard / Doble Efecto

Carrera	Diametro del cilindro en milímetros				
	12	16	20	25	32
5 mm	CC1205				
10 mm	CC1210	CC1610	CC2010	CC2510	CC3210
15 mm	CC1215	CC1615	CC2015	CC2515	CC3215
20 mm	CC1220	CC1620	CC2020	CC2520	CC3220
25 mm	CC1225	CC1625	CC2025	CC2525	CC3225
30 mm			CC2030	CC2530	CC3230
40 mm			CC2040	CC2540	CC3240
50 mm				CC2550	CC3250
75 mm				CC2575	CC3275
100 mm				CC25100	CC32100
Ø Vástago	6 mm	8 mm	10 mm	12 mm	16 mm
Conexión	M5	M5	M5	M5	1/8"

Carrera	Diametro del cilindro en milímetros				
	40	50	63	80	100
10 mm	CC4010	CC5010			
15 mm	CC4015	CC5015	CC6315	CC8015	CC10015
20 mm	CC4020	CC5020			
25 mm	CC4025	CC5025	CC6325	CC8025	CC10025
30 mm	CC4030	CC5030			
40 mm	CC4040	CC5040			
50 mm	CC4050	CC5050	CC6350	CC8050	CC10050
75 mm	CC4075	CC5075			
100 mm	CC40100	CC50100			
Ø Vástago	16 mm	20 mm	20 mm	25 mm	32 mm
Conexión	1/8"	1/4"	1/4"	3/8"	3/8"

Modelos Standard / Simple Efecto

Carrera	Diametro del cilindro en milímetros				
	12	16	20	25	32
15 mm	CCR1215	CCR1615	CCR2015	CCR2515	CCR3215
25 mm	CCR1225	CCR1625	CCR2025	CCR2525	CCR3225

* Para carreras no standard y cilindros de doble vástago consulte con su distribuidor

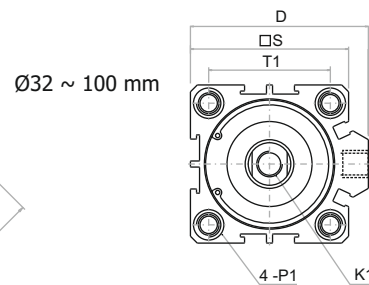
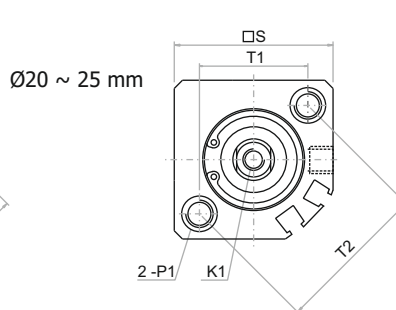
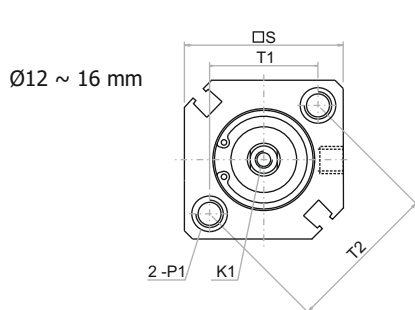
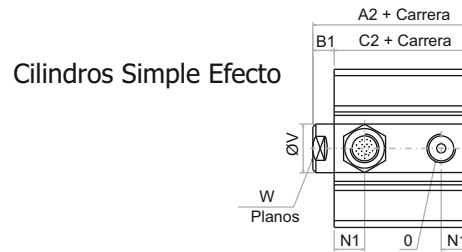
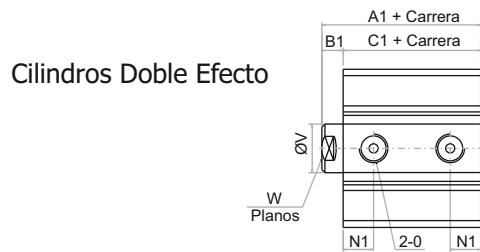

Diámetro	A1	A2 15mm	A2 25mm	B1	C1	C2 15mm	C2 25mm	D	K1
12 mm	31,5	41,5	-	3,5	28	38	-	-	M3
16 mm	34	44	-	3,5	30,5	40,5	-	-	M4
20 mm	36	46	51	4,5	31,5	41,5	46,5	-	M5
25 mm	37,5	47,5	52,5	5	32,5	42,5	47,5	-	M6
32 mm	40	50	55	7	33	43	48	49,5	M8
40 mm	46,5	-	-	7	39,5	-	-	57	M8
50 mm	48,5	-	-	8	40,5	-	-	71	M10
63 mm	54	-	-	8	46	-	-	84	M10
80 mm	63,5	-	-	10	53,5	-	-	104	M16
100 mm	75	-	-	12	63	-	-	123,5	M20

Diámetro	N1	O	P1	S	T1	T2	ØV	W
12 mm	9	M5	M4	25	15,5	22	6	5
16 mm	9,5	M5	M4	29	20	28	8	6
20 mm	9,5	M5	M6	36	25,5	36	10	8
25 mm	11	M5	M6	40	28	40	12	10
32 mm	10,5	1/8"	M6	45	34	-	16	14
40 mm	11	1/8"	M6	53	40	-	16	14
50 mm	10,5	1/4"	M8	64	50	-	20	17
63 mm	15	1/4"	M10	77	60	-	20	17
80 mm	16	3/8"	M12	98	77	-	25	22
100 mm	20	3/8"	M12	117	94	-	32	27

Sensores Magnéticos

Tipo Red Switch con LED (2 hilos)



Descripción	Referencia : CUSS01		
Contacto	Normalmente abierto	Rango de voltaje	5 ~ 240V AC / DC
Indicador	con Led superior	Rango de corriente	5 ~ 100 mA
Temperatura	0 a 60 °C ~ 32 a 140 °F	Tiempo de respuesta	5 ms
Protección	IP 64		



Características

- Están constituidos por dos cilindros paralelos
- Por su doble embolo la fuerza se duplica (Ver las tablas de fuerzas teóricas y multiplicar x 2)
- Modelos con embolo magnético para control de posición
- Máxima garantía de antigiro, pandeo y solidez en la instalación
- No requieren lubricación

Doble efecto



Datos Técnicos

Fluido:

Aire comprimido Filtrado, lubricado o no lubricado

Presión de Trabajo:

1 a 9 Bar ~ 14 a 130 PSI

Temperatura de Trabajo:

-5°C a 70°C ~ 23°F a 158°F

Carrera Ajustable:

-10 ~ 0 mm

Amortiguación:

Elástica

Materiales

Cuerpo:

Aleación de Aluminio

Vástago:

Acero al carbón con 20µ de superficie cromo-endurecida

Empaques:

Goma nitrílica

Modelos Standard / Doble Efecto

Carrera	Diametro del cilindro en milímetros			
	16	20	25	32
30 mm	CT16030	CT20030	CT25030	CT32030
40 mm	CT16040	CT20040	CT25040	CT32040
50 mm	CT16050	CT20050	CT25050	CT32050
60 mm	CT16060	CT20060	CT25060	CT32060
80 mm	CT16080	CT20080	CT25080	CT32080
100 mm	CT16100	CT20100	CT25100	CT32100
150 mm		CT20150	CT25150	CT32150
200 mm			CT25200	CT32200
Ø Vástago	8 mm	10 mm	12 mm	16 mm
Conexión	M5	M5	M5	1/8"
Empaques	CTK016	CTK020	CTK025	CTK032

* Para carreras no standard y cilindros de doble vástago consulte con su distribuidor

Sensores Magnéticos

Tipo Red Switch con LED (2 hilos)



Descripción	Referencia : CTSS01		
Contacto	Normalmente abierto	Rango de voltaje	5 ~ 240V AC / DC
Indicador	con Led superior	Rango de corriente	AC 5 ~ 100 mA
Temperatura	0 a 60 °C ~ 32 a 140 °F		DC 5 ~ 100 mA
Protección	IP 64	Tiempo de respuesta	5 ms

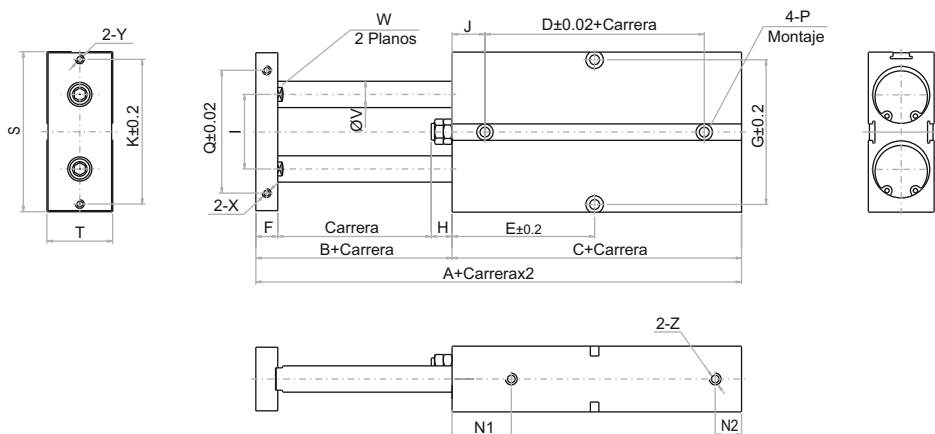

Diámetro	A	B	C	D	E - 30	E - 50	E - 80	E - 100	E - 150
16 mm	68	15	53	60	40	50	65	75	100
20 mm	78	20	58	60	40	50	65	75	100
25 mm	81	19	62	70	45	55	70	80	105
32 mm	108	30	78	75	55	65	80	90	115

Diámetro	F	G	H	I	J	K	N1	N2	ØP
16 mm	8	47	7	24	15	47	22	11	4,5
20 mm	10	55	10	28	15	55	25	12	4,5
25 mm	10	66	9	34	15	66	27	12	4,5
32 mm	17	83	13	42	17	83	40	14	5,5

Diámetro	Q	S	T	V	W	X	Y	Z
16 mm	34	53	20	8	6,1	M4 x 0,7	M4 x 0,7	M5 x 0,8
20 mm	44	61	24	10	8,1	M4 x 0,7	M4 x 0,7	M5 x 0,8
25 mm	56	72	29	12	10,1	M4 x 0,7	M4 x 0,7	M5 x 0,8
32 mm	72	94	38,3	16	14,1	M8 x 1,25	M6 x 1	1/8"

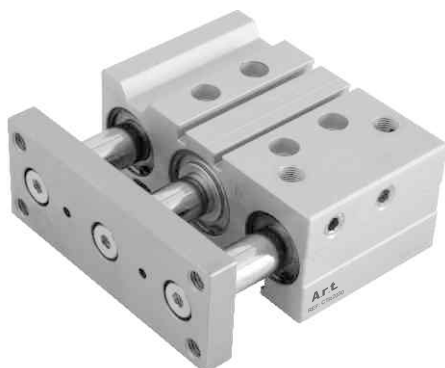

Doble efecto

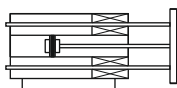

Datos Técnicos

Fluido:

Aire comprimido Filtrado,
lubricado o no lubricado

Presión de Trabajo:

1 a 10 Bar ~ 14 a 145 PSI

Temperatura de Trabajo:

-20°C a 70°C ~ -4°F a 158°F

Amortiguación:

Elástica

Características

- Alta resistencia a cargas radiales y torsión
- Doble guía con bujes de bronce que son garantía de antigiro, pandeo y solidez en la instalación
- Modelos con embolo magnético para control de posición
- El diseño del cuerpo proporciona múltiples opciones de montaje
- No requieren lubricación

Modelos Standard / Doble Efecto

Carrera	Diametro del cilindro en milímetros						
	16	20	25	32	40	50	63
30 mm	CTR16030	CTR20030	CTR25030	CTR32030	CTR40030	CTR50030	CTR63030
40 mm	CTR16040	CTR20040	CTR25040	CTR32040	CTR40040	CTR50040	CTR63040
50 mm	CTR16050	CTR20050	CTR25050	CTR32050	CTR40050	CTR50050	CTR63050
60 mm	CTR16060	CTR20060	CTR25060	CTR32060	CTR40060	CTR50060	CTR63060
80 mm	CTR16080	CTR20080	CTR25080	CTR32080	CTR40080	CTR50080	CTR63080
100 mm	CTR16100	CTR20100	CTR25100	CTR32100	CTR40100	CTR50100	CTR63100
150 mm	CTR16150	CTR20150	CTR25150	CTR32150	CTR40150	CTR50150	CTR63150
200 mm	CTR16200	CTR20200	CTR25200	CTR32200	CTR40200	CTR50200	CTR63200
Ø Vástago	8 mm	10 mm	12 mm	16 mm	16 mm	20 mm	20 mm
Conexión	M5	1/8"	1/8"	1/8"	1/8"	1/4"	1/4"

* Para carreras no standard consulte con su distribuidor

Materiales

Cuerpo:

Aleación de Aluminio

Vástago:

Acero al carbón con 20µ de
superficie cromo-endurecida

Empaques:

Goma nitrílica

Sensores Magnéticos

Tipo Red Switch

con LED (2 hilos)



Descripción	Referencia : CUSS01
Contacto	Normalmente abierto
Indicador	con Led superior
Temperatura	0 a 60 °C ~ 32 a 140 °F
Protección	IP 64
Rango de voltaje	5 ~ 240V AC / DC
Rango de corriente	0 ~ 100 mA
Resistencia a la vibración	10 ~ 50 Hz
Tiempo de respuesta	5 ms
Longitud de Cable	2 Mts.

CILINDROS TRI-ROD

SERIE CTR

Art

CILINDROS

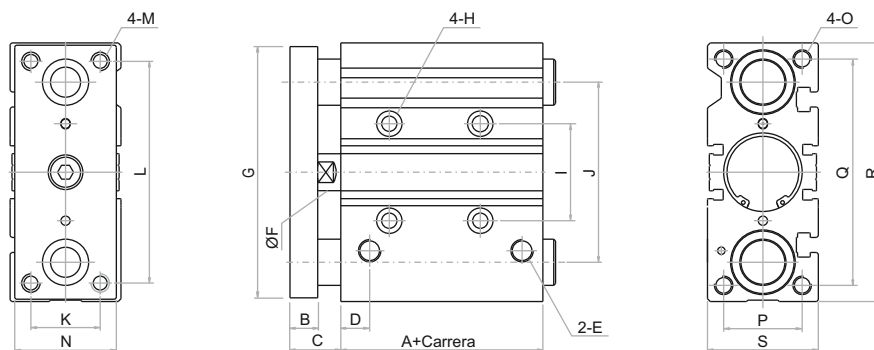

Diámetro	A	B	C	D	E	F	G	H	I
16 mm	33	8	13	5	M5 x 0,8	8	62	4,5	24
20 mm	37	10	16	17	1/8"	10	81	5,5	28
25 mm	37,5	10	16	17	1/8"	12	91	5,5	34
32 mm	37,5	12	22	21	1/8"	16	110	6,5	42
40 mm	44	12	22	22	1/8"	16	118	6,5	50
50 mm	44	16	28	24	1/4"	20	146	8,5	66
63 mm	49	16	28	24	1/4"	20	158	8,5	80

Diámetro	J	K	L	M	N	O	P	Q	R	S
16 mm	46	16	54	M5 x 0.8	25	M5 x 0.8	22	56	64	30
20 mm	54	18	70	M5 x 0.8	30	M5 x 0.8	24	72	83	36
25 mm	64	26	78	M6 x 1.0	38	M6 x 1.0	30	82	93	42
32 mm	78	30	96	M8 x 1.25	44	M8 x 1.25	34	98	112	48
40 mm	86	30	104	M8 x 1.25	44	M8 x 1.25	40	106	120	54
50 mm	110	40	130	M10 x 1.5	60	M10 x 1.5	46	130	148	64
63 mm	124	50	130	M10 x 1.5	70	M10 x 1.5	58	142	162	78



Características

- Especiales para ensambles con una alta condición de precisión
- Rodamientos incorporados al cilindro que garantizan una alta precisión, rigidez y capacidad de carga
- Excelente linealidad y antigiro
- Modelos con embolo magnético para control de posición
- No requieren lubricación

Doble efecto



Datos Técnicos

Fluido:

Aire comprimido Filtrado,
lubricado o no lubricado

Presión de Trabajo:

1.5 a 7 Bar ~ 22 a 110 PSI

Temperatura de Trabajo:

-20°C a 70°C ~ -4°F a 158°F

Amortiguación:

Amortiguador de choque

Modelos Standard / Doble Efecto

Carrera	Diametro del cilindro en milímetros		
	16	20	25
10 mm	CCD16010	CCD20010	CCD25010
20 mm	CCD16020	CCD20020	CCD25020
30 mm	CCD16030	CCD20030	CCD25030
40 mm	CCD16040	CCD20040	CCD25040
50 mm	CCD16050	CCD20050	CCD25050
75 mm	CCD16075	CCD20075	CCD25075
100 mm	CCD16100	CCD20100	CCD25100
125 mm	CCD16125	CCD20125	CCD25125
150 mm		CCD20150	CCD25150
Ø Vástago	8 mm	10 mm	12 mm
Conexión	M5	1/8"	1/8"

* Para carreras no standard consulte con su distribuidor

Materiales

Cuerpo:

Aleación de Aluminio

Vástago:

Acero al carbón con 20µ de
superficie cromo-endurecida

Empaques:

Goma nitrílica

Amortiguador
de choque

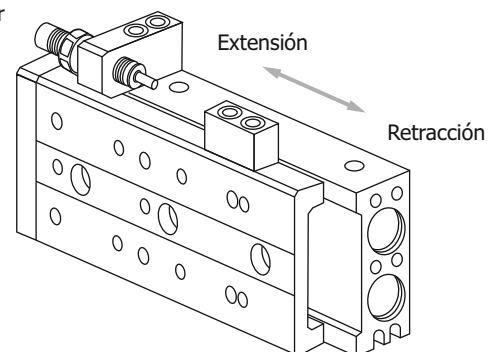

CILINDROS COMPACTOS TIPO MESA DESLIZANTE

SERIE CCD

Art

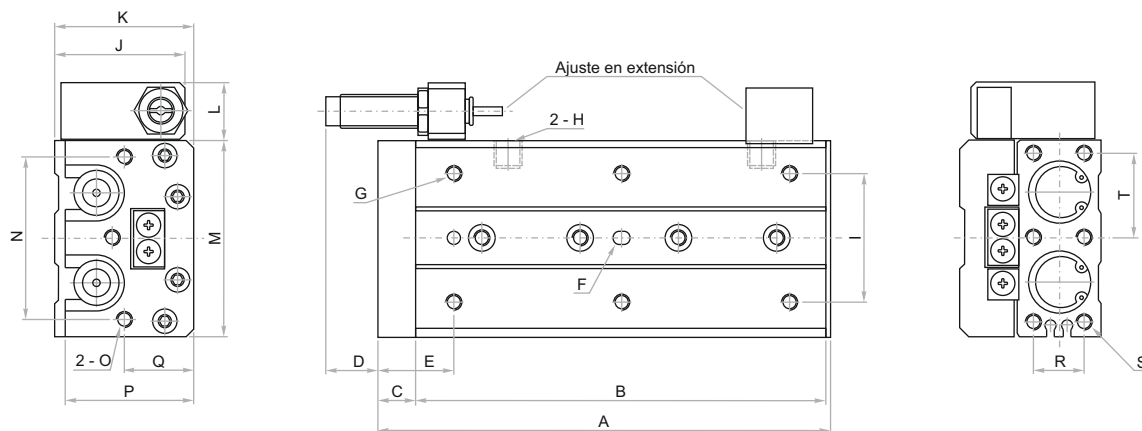

Cilindros Ø 16 mm

Carrera	10 mm	20 mm	30 mm	40 mm	50 mm	75 mm	100 mm	125 mm
A	87	87	87	97	112	162	210	260
B	75	75	75	85	100	150	198	248

Cilindros Ø 20 mm

Carrera	10 mm	20 mm	30 mm	40 mm	50 mm	75 mm	100 mm	125 mm	150 mm
A	97	97	97	107	122	161	214	268	320
B	81,5	81,5	81,5	91,5	106,5	145,5	198,5	252,5	304,5

Cilindros Ø 25 mm

Carrera	10 mm	20 mm	30 mm	40 mm	50 mm	75 mm	100 mm	125 mm	150 mm
A	108	108	108	118	131	172	213	271	311
B	90,5	90,5	90,5	100,5	113,5	154,5	195,5	253,5	293,5

Generales

Diámetro	C	D	E	F	G	H	I	J	K
16 mm	10	18,5	21	6 x 5	M5 x 0,8	M5 x 0,8	35	37,5	40
20 mm	13	14,5	27	6 x 5	M5 x 0,8	1/8"	46	46,5	50
25 mm	15	26	30	7 x 6	M6 x 1	1/8"	56	56,5	62

Diámetro	L	M	N	O	P	Q	R	S	T
16 mm	16,5	60	48	M6 x 1	36	20	12	4 - M5x0,8	26
20 mm	21	70	58	M6 x 1	45	25	18	6 - M5x0,8	30
25 mm	23	84	70	M8 x 1.25	56,5	31	22	6 - M6x1	38



Características

- Los cilindros CI de 16, 20 y 25 mm cumplen con la norma ISO 6432
- Resistente a la corrosión
- Modelos con embolo magnético para control de posición
- Se suministra con tuerca de fijación y contratuerca del vástago
- No requieren lubricación

Doble efecto

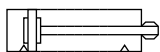

Simple efecto

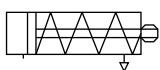

Datos Técnicos

Fluido:

Aire comprimido Filtrado,
lubricado o no lubricado

Presión de Trabajo:

1 a 10 Bar ~ 14 a 145 PSI

Temperatura de Trabajo:

-20°C a 70°C ~ -4°F a 158°F

Amortiguación:

Elástica

Modelos Standard / Doble Efecto

Carrera mm (Pulg)	Diámetro del cilindro en milímetros				
	16	20	25	32	40
25 (1")	CI16025	CI20025	CI25025	CIB32025	CIB40025
50 (2")	CI16050	CI20050	CI25050	CIB32050	CIB40050
75 (3")	CI16075	CI20075	CI25075	CIB32075	CIB40075
80 (3,15")	CI16080	CI20080	CI25080	CIB32080	CIB40080
100 (4")	CI16100	CI20100	CI25100	CIB32100	CIB40100
125 (5")	CI16125	CI20125	CI25125	CIB32125	CIB40125
150 (6")	CI16150	CI20150	CI25150	CIB32150	CIB40150
175 (7")	CI16175	CI20175	CI25175	CIB32175	CIB40175
200 (8")	CI16200	CI20200	CI25200	CIB32200	CIB40200
225 (9")	CI16225	CI20225	CI25225	CIB32225	CIB40225
250 (10")	CI16250	CI20250	CI25250	CIB32250	CIB40250
275 (11")		CI20275	CI25275	CIB32275	CIB40275
300 (12")		CI20300	CI25300	CIB32300	CIB40300
Ø Vástago	6 mm	8 mm	10 mm	12 mm	16 mm
Conexión	M5	G1/8	G1/8	G1/8	G1/8

Materiales

Camisa:

Acero inoxidable 304

Cabezas:

Aluminio inyectado

Vástago:

Acero inoxidable 304

Empaques:

NBR

Modelos Standard / Simple Efecto

Carrera mm (Pulg)	Diámetro del cilindro en milímetros		
	16	20	25
25 (1")	CIR16025	CIR20025	CIR25025
50 (2")	CIR16050	CIR20050	CIR25050
75 (3")	CIR16075	CIR20075	CIR25075
100 (4")	CIR16100	CIR20100	CIR25100

* Para carreras no standard y cilindros de doble vástago consulte con su distribuidor



Doble efecto

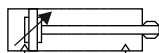

Características

- Norma: ISO 6432
- Amortiguación neumática regulable
- Resistente a la corrosión
- Modelos con embolo magnético para control de posición
- Se suministra con tuerca de fijación y contratuerca del vástago
- No requieren lubricación

Datos Técnicos

Fluido:

Aire comprimido Filtrado, lubricado o no lubricado

Presión de Trabajo:

1 a 10 Bar ~ 14 a 145 PSI

Temperatura de Trabajo:

-20°C a 70°C ~ -4°F a 158°F

Amortiguación:

Regulable

Materiales

Camisa:

Acero inoxidable 304

Cabezas:

Aluminio inyectado

Vástago:

Acero inoxidable 304

Empaques:

NBR

Modelos Standard / Doble Efecto

Carrera mm (Pulg)	Diametro del cilindro en milímetros		
	16	20	25
25 (1")	CIA16025	CIA20025	CIA25025
50 (2")	CIA16050	CIA20050	CIA25050
75 (3")	CIA16075	CIA20075	CIA25075
80 (3,15")	CIA16080	CIA20080	CIA25080
100 (4")	CIA16100	CIA20100	CIA25100
125 (5")	CIA16125	CIA20125	CIA25125
150 (6")	CIA16150	CIA20150	CIA25150
175 (7")	CIA16175	CIA20175	CIA25175
200 (8")	CIA16200	CIA20200	CIA25200
225 (9")	CIA16225	CIA20225	CIA25225
250 (10")	CIA16250	CIA20250	CIA25250
275 (11")		CIA20275	CIA25275
300 (12")		CIA20300	CIA25300
Ø Vástago	6 mm	8 mm	10 mm
Conexión	M5	G1/8	G1/8

* Para carreras no standard consulte con su distribuidor

Ø	CIP - Pies	CIF - Flanche	CIPP - Pivote Hembra
Ø	Referencia	Referencia	Referencia
16	CIP16	CIF16	CIPP16
20	CIP25	CIF25	CIPP25
25	CIP25	CIF25	CIPP25
32	CIP32	CIF32	CIPP32
40	CIP40	CIF40	CIPP40

Ø	CIH - Horquilla	CIR - Rotula	CIA - Autoalineador	CIS - Soporte Sensor
Ø	Referencia	Referencia	Referencia	Referencia
16	CIH16	CIR16		CIS16
20	CIH20	CIR20		CIS20
25	CIH32	CIR32	CIAU32	CIS25
32	CIH32	CIR32	CIAU32	CIS32
40	CIH40	CIR40	CIAU40	CIS40



Sensores Magnéticos
Tipo Red Switch con LED (2 hilos)

Descripción	Referencia: CUSS01
Contacto	Normalmente abierto
Indicador	Con LED Superior
Temperatura	0 a 60 °C ~ 32 a 140 °F
Protección	IP 64
Rango de voltaje	5 ~ 240V AC / DC
Rango de corriente	5 ~ 100 mA
Resistencia a la vibración	10 ~ 50 Hz
Tiempo de respuesta	5 ms
Longitud de Cable	2 Mts.

Cilindros Doble Efecto

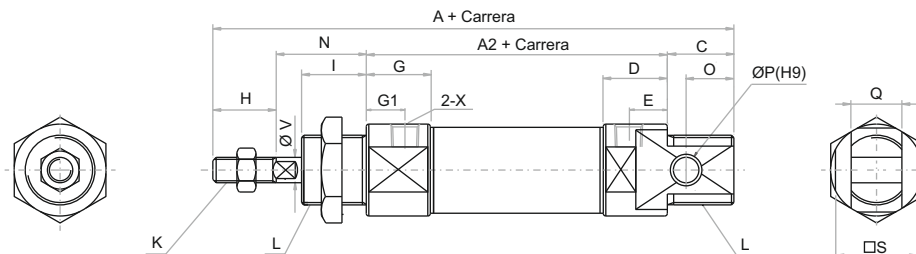

Cilindros Simple Efecto

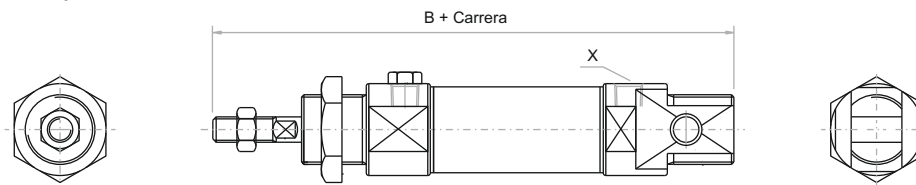

Diámetro	A	A2	B 0 ~ 50	B 50 ~ 100	C	D	E	G	G1	H
16 mm	111	56	136	161	17	10,5	6	12,5	8	16
20 mm	126	62	151	176	20	14,5	7,5	14,5	7,5	20
25 mm	137	65	162	187	22	16	8	16	8	22
32 mm	147	76	-	-	27	16	8	16	8	22
40 mm	149	76	-	-	27	16,7	8,4	16,7	8,4	24

Diámetro	I	K	L	N	O	P	Q	S	V	X
16 mm	17	M 6 x 1	M 16 x 1,5	22	13	6	12	20	6	M5
20 mm	20	M 8 x 1,25	M 22 x 1,5	24	11	8	16	25	8	G1/8"
25 mm	22	M 10 x 1,25	M 22 x 1,5	28	11	8	16	30	10	G1/8"
32 mm	14	M 10 x 1,25	M 24 x 2	22	12	10	16	Ø35	12	G1/8"
40 mm	14	M 12 x 1,25	M 30 x 2	22	12	12	20	Ø41,6	16	G1/8"

Cilindros Doble Vástago

Diámetro	A	A1
16 mm	134	58
20 mm	150	62
25 mm	165	65
32 mm	164	76
40 mm	168	76

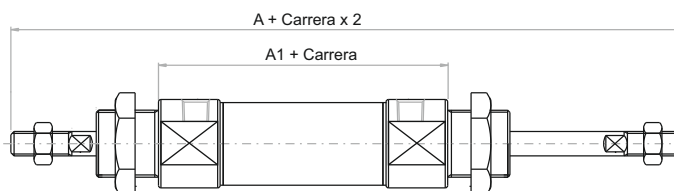

Cilindros Doble Efecto

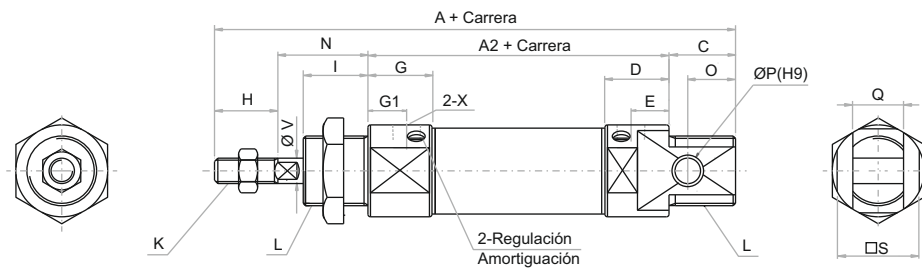

Diámetro	A	A2	C	D	E	G	G1	H	I
16 mm	111	56	17	12,1	6	12,1	7,5	16	17
20 mm	126	62	20	14,5	7,5	14,5	7,5	20	20
25 mm	137	65	22	16	8	16	8	22	22

Diámetro	K	L	N	O	P	Q	S	V	X
16 mm	M 6 x 1	M 16 x 1,5	22	13	6	12	20	6	M5
20 mm	M 8 x 1,25	M 22 x 1,5	24	11	8	16	25	8	G1/8"
25 mm	M 10 x 1,25	M 22 x 1,5	28	11	8	16	30	10	G1/8"

Cilindros Doble Vástago

Diámetro	A	A1
16 mm	132,4	56,4
20 mm	150	62
25 mm	165	65

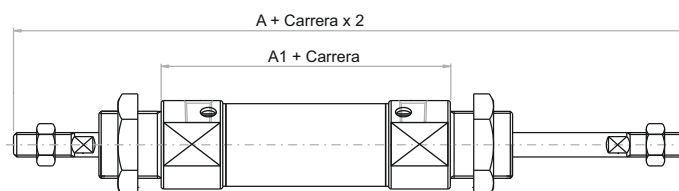

Pies

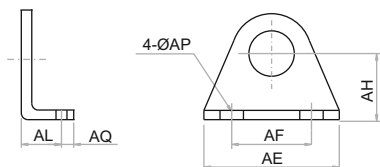

Diam.	AE	AF	AL	AQ	ØAP	AH
16	44	32	13	6	5,5	20
20 / 25	54	40	15	8	6,5	25
32	59	45	25	8	6,5	32
40	64	50	25	8	6,5	36

Horquilla

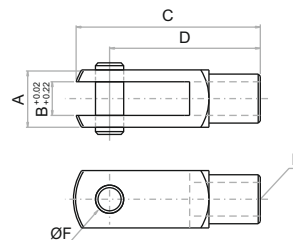

Diam.	A	B	C	D	E	ØF
16	12	6	32	24	M6 x 1	6
20	16	8	42	32	M8 x 1,25	8
25 / 32	19	10	52	40	M10 x 1,25	10
40	25,4	14	57	45	M12 x 1,25	10

Pivote

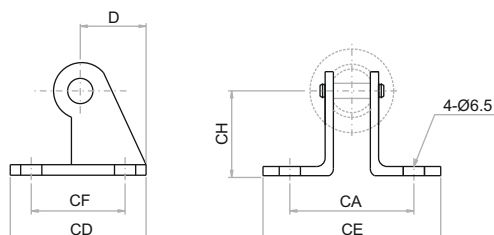

Diam.	D	CA	CD	CE	CF	CH
16	16	-	23	-	12	20
20 / 25	21	51	48	67	32	32
32	27	51	52	67	36	36
40	27	55	56	71	40	40

Rótula

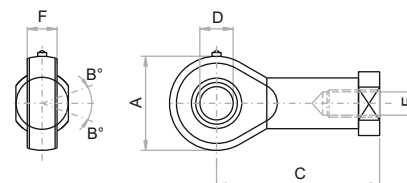

Diam.	A	B	C	ØD	E	F
20	24	13	36	8	M8 x 1,25	9
25 / 32	26	13	43	10	M10 x 1,25	11
40	32	13	50	12	M12 x 1,25	12

Flanche

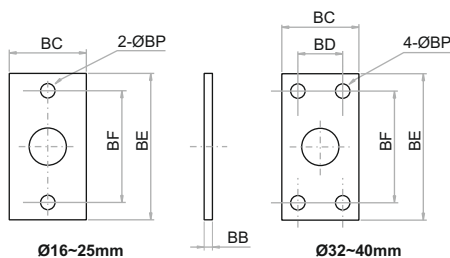

Diam.	BB	BC	BD	BE	BF	ØBP
16	3	26	-	52	40	5,5
20 / 25	4	38	-	64	50	6,5
32	4	47	33	72	58	6,5
40	4	50	36	84	70	6,5

Autoalineador

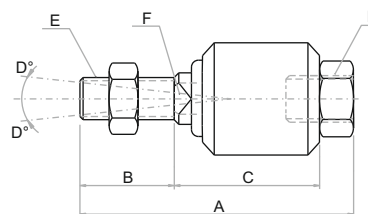

Diam.	A	B	C	D	E	F
20	51	20	23	13	M8 x 1,25	8
25 / 32	58	22	28	12	M10 x 1,25	10
40	58	22	29	12	M12 x 1,25	12



Características

- Proporcionan una gran velocidad de respuesta
- Resistentes a la corrosión
- Versiones en doble ó simple efecto
- Ideales para aplicaciones de sujetar, prensar, transportar, alimentación de piezas, etc.

Doble efecto

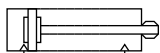

Simple efecto

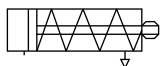

Datos Técnicos

Fluido:

Aire comprimido Filtrado, lubricado o no lubricado

Presión de Trabajo:

1 a 7 Bar ~ 15 a 101 PSI

Temperatura de Trabajo:

0°C a 60°C ~ 32°F a 140°F

Amortiguación:

Elástica

Cilindros de Doble Efecto

Carrera Pulg (mm)	Diámetro del cilindro en pulgadas				
	7/16"	3/4"	1-1/16"	1-1/2"	2"
1 (25)	CIP0401	CIP0501	CIP0701	CIP0801	CIP1001
2 (50)	CIP0402	CIP0502	CIP0702	CIP0802	CIP1002
3 (75)		CIP0503	CIP0703	CIP0803	CIP1003
4 (100)			CIP0704	CIP0804	CIP1004
5 (125)			CIP0705	CIP0805	CIP1005
6 (150)			CIP0706	CIP0806	CIP1006
Ø Vástago	0,187 (4,75mm)	0,25 (6,35mm)	0,312 (7,92mm)	0,437 (11,09mm)	0,625 (15,87mm)
Conexión	10/32 UNF	1/8 NPT	1/8 NPT	1/8 NPT	1/4 NPT

Materiales

Camisa:

Acero inoxidable

Cabezas:

Aluminio Anodizado

Vástago:

Acero inoxidable 303

Empaques:

Buna N

Cilindros de Simple Efecto

Carrera Pulg (mm)	Diámetro del cilindro en pulgadas		
	7/16"	3/4"	1-1/16"
1 (25)	CIPR0401	CIPR0501	CIPR0701
2 (50)	CIPR0402	CIPR0502	CIPR0702
3 (75)			CIPR0703
Ø Vástago	0,187 (4,75mm)	0,25 (6,35mm)	0,312 (7,92mm)
Conexión	10/32 UNF	1/8 NPT	1/8 NPT

CILINDROS EN ACERO INOXIDABLE SERIE CIP

MONTAJES

Art

Ø	CIPP - Pies	CIPPP - Pivote	CIPH - Horquilla	CIPT - Tuerca de Montaje
---	-------------	----------------	------------------	--------------------------

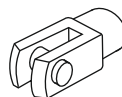

Ø	Referencia	Referencia	Referencia
7/16"			CIPT04
3/4"	CIPPP07	CIPH05	CIPT05
1 - 1/16"	CIPPP07	CIPH07	CIPT05
1 - 1/2"	CIPPP08	CIPH08	CIPT08
2"	CIPPP10	CIPH10	CIPT10

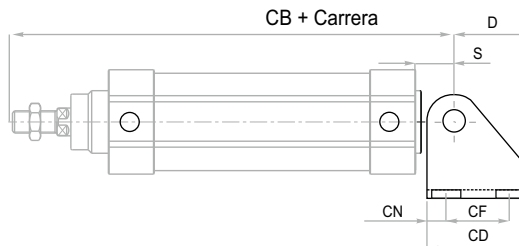
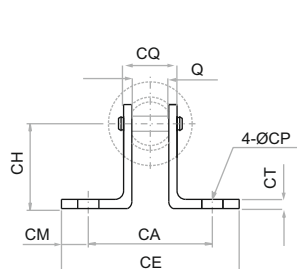

Pivote

Pulg.

Diam.	CQ	D	ØE	CH	CD
3/4"	0,63	0,81	0,25	0,88	1,12
1 1/16"	0,63	0,81	0,25	0,88	1,12
1 1/2"	0,87	1,13	0,38	1,38	1,50
2"	1,08	1,13	0,38	1,38	1,50

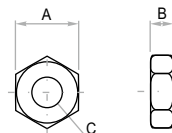
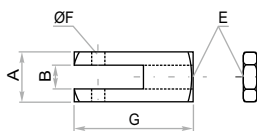

Horquilla

Pulg.

Diam.	A	B	E	ØF	G
3/4"	0,50	0,25	1/4-28 UNF	0,26	1,19
1 1/16"	0,50	0,25	5/16-24 UNF	0,26	1,19
1 1/2"	0,75	0,38	7/16-20 UNF	0,38	1,69
2"	0,75	0,38	1/2-20 UNF	0,38	1,69

Tuerca de Montaje

Pulg.

Diametro	A	B	C
7/16"	0,68	0,25	7/16-20 UNF
3/4"	0,93	0,37	5/8-18 UNF
1 - 1/16"	0,93	0,37	5/8-18 UNF
1 - 1/2"	1,5	0,5	1-14 UNF
2"	1,88	0,50	1,1/4-12 UNF

CILINDROS EN ACERO INOXIDABLE SERIE CIP

DOBLE EFECTO EN PULGADA

Art

Cil. Doble Efecto
7/16"

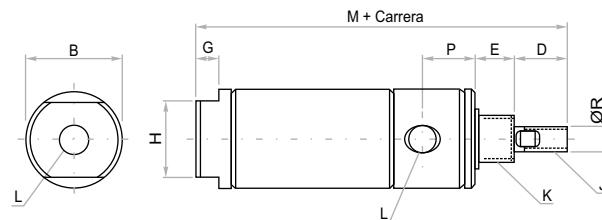

Cil. Doble Efecto
3/4", 1 1/16", 1 1/2", 2"

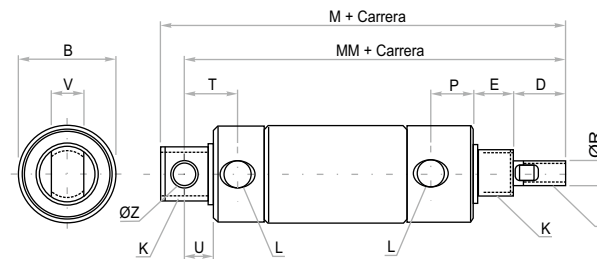

Cil. Doble Efecto - 7/16"

Ø	B	D	E	G	H	J	K	L	M	P	ØR
7/16"	0,62	0,50	0,41	0,12	0,37	10-32 UNF	7/16-20 UNF	10-32 UNF	2,62	0,37	0,187

Pulg.

Cil. Doble Efecto - 3/4" ~ 2"

Ø	B	D	E	J	K	L	M
3/4"	0,86	0,50	0,50	1/4-28 UNF	5/8-18 UNF	1/8 NPT	4,54
1 1/16"	1,14	0,62	0,50	5/16-24 UNF	5/8-18 UNF	1/8 NPT	4,62
1 1/2"	1,58	1,00	0,62	7/16-20 UNF	3/4-16 UNF	1/8 NPT	5,50
2"	2,10	1,25	0,81	1/2-20 UNF	1,1/4-12 UNF	1/4 NPT	6,93

Pulg.

Ø	MM	P	ØR	T	U	V	ØZ
3/4"	4,25	0,37	0,25	0,71	0,34	0,38	0,25
1 1/16"	4,34	0,39	0,312	0,73	0,34	0,38	0,25
1 1/2"	5,12	0,43	0,437	0,93	0,50	0,62	0,38
2"	6,50	0,51	0,625	1,07	0,57	0,75	0,38

Cil. Simple Efecto
7/16"

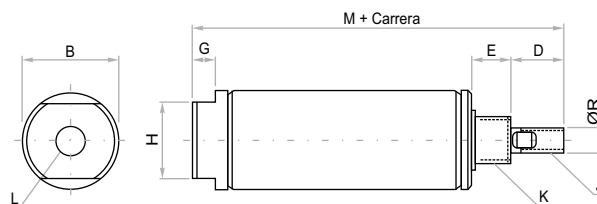

Cil. Simple Efecto
3/4", 1 1/16"

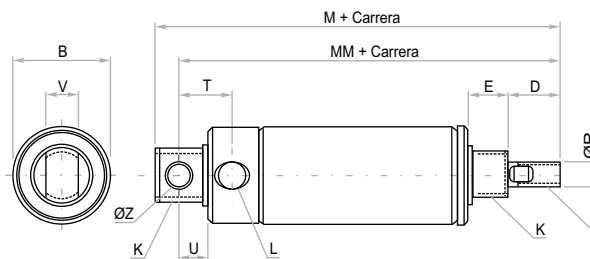

Cil. Simple Efecto - 7/16"

Ø	B	D	E	G	H	J	K	L	M	ØR	Pulg.
7/16"	0,56	0,50	0,31	0,12	0,37	10-32 UNF	3/8-24 UNF	10-32 UNF	1,81	0,187	

Cil. Simple Efecto - 3/4", 1 1/16"

Ø	B	D	E	J	Nariz K	Pivote K	L	Pulg.
3/4"	0,86	0,50	0,50	1/4-28 UNF	5/8-18 UNF	5/8-18 UNF	1/8 NPT	
1 1/16"	1,14	0,62	0,50	5/16-24 UNF	5/8-18 UNF	5/8-18 UNF	1/8NPT	

Ø	M	MM	ØR	T	U	V	ØZ
3/4"	4,66	4,38	0,25	0,71	0,34	0,38	0,25
1 1/16"	4,75	4,47	0,31	0,73	0,34	0,38	0,25



Características

- Especiales para uso en prensas de sujeción en la aplicación de soldadura automática
- Posee un anillo especial en la cabeza delantera que lo hace más resistente a las salpicaduras de soldadura
- Amortiguación y control de velocidad regulables, incorporados al cilindro
- Modelos con embolo magnético para control de posición
- No requieren lubricación

Doble efecto

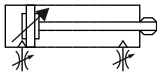

Datos Técnicos

Fluido:

Aire comprimido Filtrado, lubricado o no lubricado

Presión de Trabajo:

0.5 a 10 Bar ~ 8 a 145 PSI

Temperatura de Trabajo:

-20°C a 80°C ~ -4°F a 176°F

Amortiguación:

Regulable

Modelos Standard / Doble Efecto

Carrera	Diámetro del cilindro en milímetros			
	40	50	63	80
50 mm	CCL40050	CCL50050	CCL63050	CCL80050
75 mm	CCL40075	CCL50075	CCL63075	CCL80075
100 mm	CCL40100	CCL50100	CCL63100	CCL80100
125 mm	CCL40125	CCL50125	CCL63125	CCL80125
150 mm	CCL40150	CCL50150	CCL63150	CCL80150
Ø Vástago	20 mm	20 mm	20 mm	25 mm
Conexión	1/4"	1/4"	1/4"	3/8"

* Para carreras no standard consulte con su distribuidor

Materiales

Cuerpo:

Aleación de Aluminio

Vástago:

Acero al carbón con 20µ de superficie cromo-endurecida

Sello Frontal:

Acero Inoxidable

Empaques:

Goma nitrílica

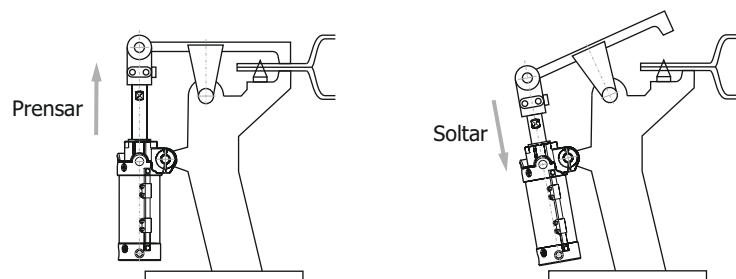

CILINDROS CLAMP

SERIE CCL

Art

CILINDROS

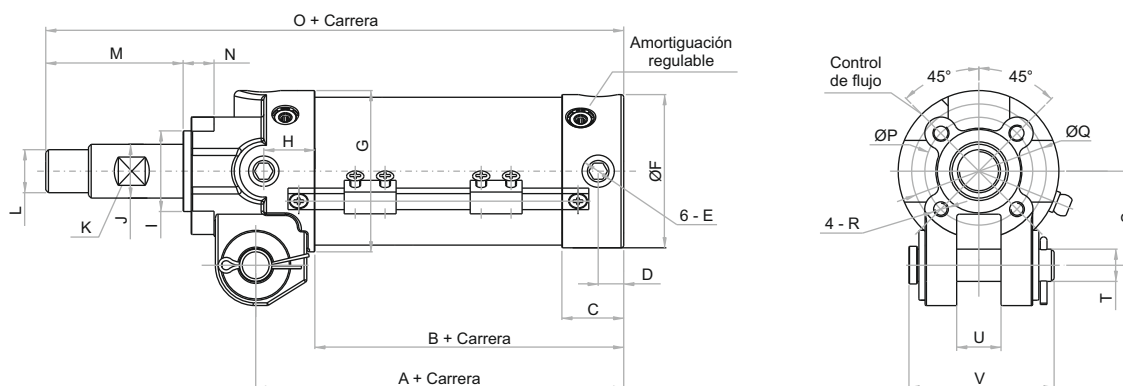

Diámetro	A	B	C	D	E	F	G
40 mm	84	59	21	9	1/4"	47	52
50 mm	87	65	23	9,5	1/4"	57	60
63 mm	89	67	23	9,5	1/4"	70	74
80 mm	127	87	35	15	3/8"	87,5	93

Diámetro	H	I	J	K	L	M	N
40 mm	20	30	20	17	M16 x 1,5	51	11,5
50 mm	19	30	20	17	M16 x 1,5	51	11,5
63 mm	19	30	20	17	M16 x 1,5	51	11,5
80 mm	20	-	25	22	M20 x 1,5	59	-

Diámetro	O	P	Q	R	S	T	U	V
40 mm	162	40	50	M6 x 1,0	35	12	19,5	54
50 mm	165	40	50	M6 x 1,0	35	12	19,5	54
63 mm	167	40	50	M6 x 1,0	35	12	19,5	54
80 mm	206	44	-	M6 x 1,0	50	18	28	72

CILINDROS SIN VASTAGO MAGNÉTICOS

SERIE RMS

Art

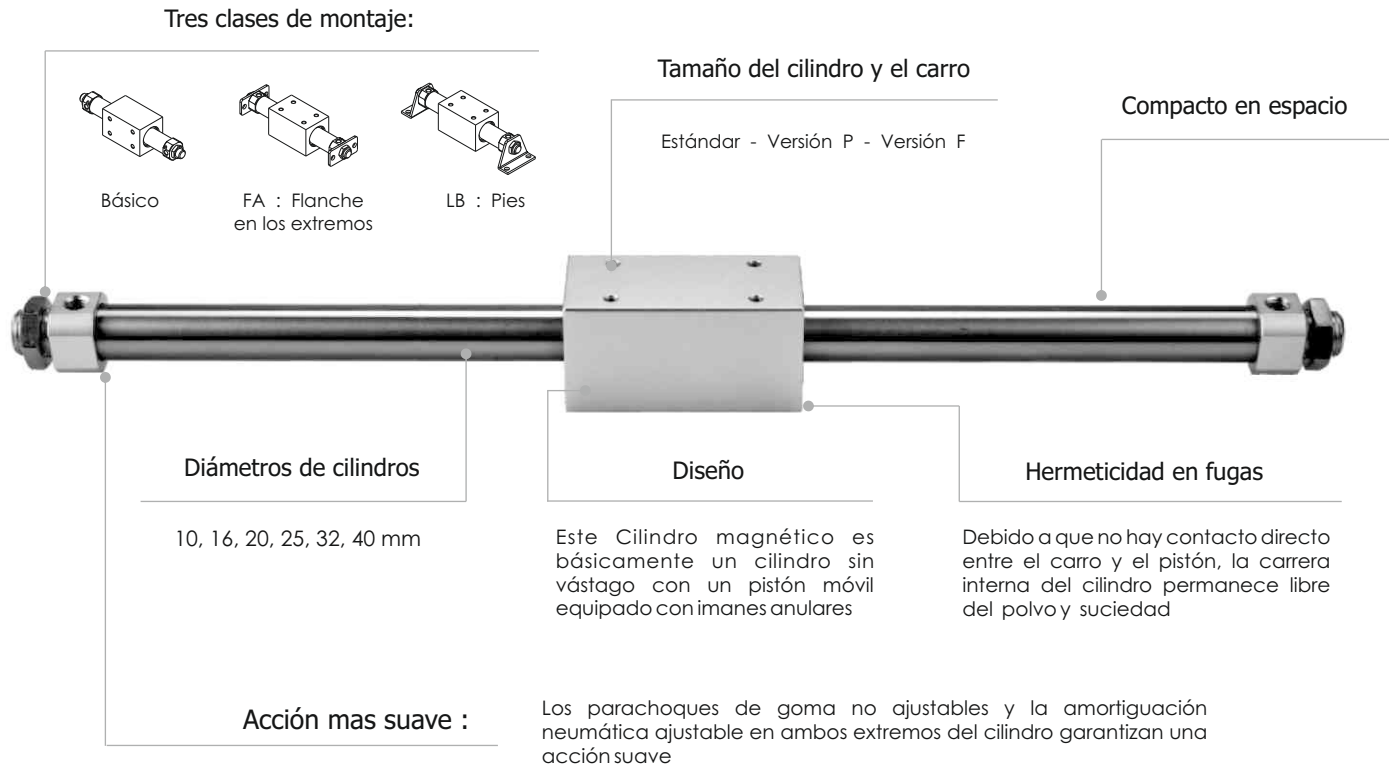

Especificaciones

Serie	RMS	RMS, RMSF						RMSP		
Diámetro (mm)	10	16	20	25	32	40	16	20	32	
Acción	Doble acción									
Fluido	Aire filtrado con elemento menor a 40 micras									
Presión de Operación	0,15 a 0,7 Mpa (22 a 100 PSI) (1,5 a 7 Bar)									
Temperatura	-20°C a 70°C									
Rango Velocidad	50 a 400 mm/seg									
Tolerancia en Carrera	De 0 a 250 mm = de 0 a 1 mm			De 251 a 1000 mm = de 0 a 1,5 mm			De 1001 mm en adelante = de 0 a 2 mm			
Tipo de Amortiguación	Parachoque		Amortiguación regulable y parachoque fijo							
Tamaño de puerto	M5 x 0,8		1/8"			1/4"	M5 x 8		1/8"	
Fuerza de Sujeción Segura Kg	5,5	14	22	34,5	56	88	14	22	56	

Diámetro	Carrera Estandar (mm)																	Máxima Carrera
10 mm	50	100	150	200	250	300												1000
16 mm	50	100	150	200	250	300	350	400	450	500								1500
20 mm	50	100	150	200	250	300	350	400	450	500	600	700	750	800	900	1000		2000
25 mm	50	100	150	200	250	300	350	400	450	500	600	700	750	800	900	1000		2500
32 mm	50	100	150	200	250	300	350	400	450	500	600	700	750	800	900	1000		3000
40 mm	50	100	150	200	250	300	350	400	450	500	600	700	750	800	900	1000		3000

Como Ordenar su Cilindro

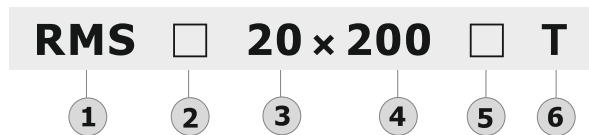

- 1** RMS cilindros sin vástago - magnético
- 2** Tamaño del cilindro y el carro
 □ : Medidas de versión básica
 P : Medidas versión P
 F : Medidas versión F
- 3** Diámetro del cilindro en (mm)
 Estándar : 10 - 16 - 20 - 25 - 32 - 40
 Versión P : 16 - 20 - 32
 Versión F : 16 - 20 - 25 - 32 - 40
- 4** Carrera del cilindro en (mm)
- 5** Tipo de montaje
 □ : Sin montaje
 LB : Montaje de pies
 FA : Flanche en los extremos
- 6** T : Rosca NPT (conexión de entrada y salida)

Como ordenar los montajes : LB o FA

Diámetro del cilindro		10	16			20		
Tipo de montaje		RMS	RMS	RMSP	RMSF	RMS	RMSP	RMSF
Montaje de pies	LB	F - PB12LB	F - RMS16LB		F - RMSF16LB	F - RMS20LB		F - RMSF20LB
Flanches en los extremos	FA	F - PB12FA	F - PB12FA		F - MI12FA	F - MF20FA		F - MA20FA

Diámetro del cilindro		25		32			40	
Tipo de montaje		RMS	RMSF	RMS	RMSP	RMSF	RMS	RMSF
Montaje de pies	LB	F - RMS25LB	F - RMSF25LB	F - RMS32LB		F - RMSF32LB	F - RMS40LB	F - RMSF40LB
Flanches en los extremos	FA	F - MF32FA	F - MA20FA	F - MF32FA		F - MA40FA	F - MF40FA	-

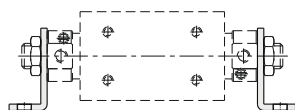

Montaje de pies : LB

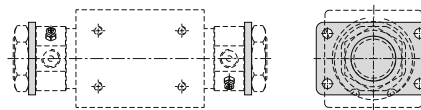
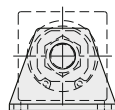

Montaje de flanche : FA

CILINDROS SIN VASTAGO MAGNETICOS

SERIE RMS

Ar.t

Versión básico
Versión P

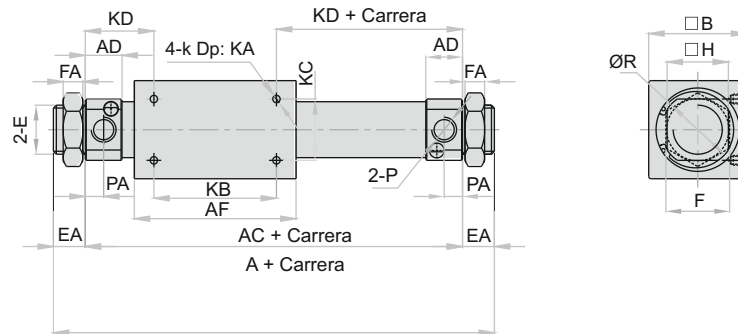

Versión : F

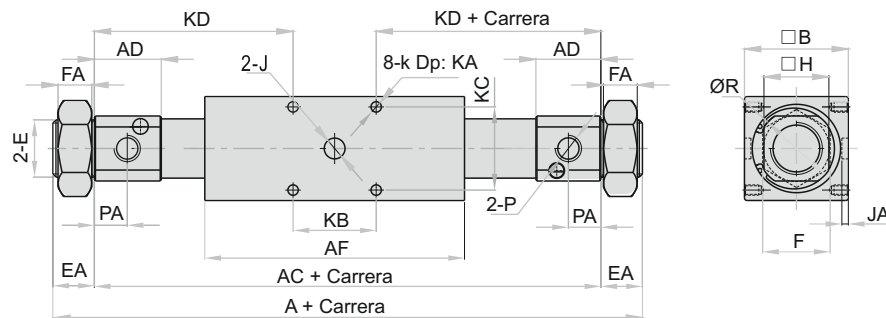

(Unidad : mm)

Modelo	A	AC	AD	AF	B	E	EA	F	FA	H	J	JA	K	KA	KB	KC	KD	P	PA	R	
RMS10	91	73	9,5	48	25	M10 x 1,0	9	14	4	15	-	-	M3 x 0,5	4	30	16	21,5	M5 x 0,8	5	17	
RMS16	103	83	10	57	35	M10 x 1,0	10	14	4	20	-	-	M4 x 0,7	5	35	19	24	M5 x 0,8	5,5	22	
RMSP16	112	92	14,5	57		M10 x 1,0	10	14	4		-	-	M4 x 0,7	7	34	25	29		7,5		
RMSF16	205	181	34	80	40	M16 x 1,5	12	23	8	25	8	3	M5 x 0,8	7,5	26	26	77,5	M5 x 0,8	20	29	
RMS20	132	106	15	66		M20 x 1,5	13	26	8		-	-	M4 x 0,7	5,5	50	25	28		1/8"		7,5
RMSP20	143	115	19,5	66	46	M20 x 1,5	14	26	8	30	-	-	M5 x 0,8	7	40	30	37,5	1/8"	10	33,5	
RMSF20	217	185	29,5	90		M22 x 1,5	16	29	7		8	2,5	M5 x 0,8	8,5	32	32	76,5		15		
RMS25	137	111	15	70	60	M26 x 1,5	13	32	8	36	-	-	M5 x 0,8	7,5	50	30	30,5	1/8"	7,5	49,5	
RMSF25	238	206	37,5	90		M22 x 1,5	16	29	7		10	3	M6 x 1,0	10	36	36	85		1/8"		20
RMS32	156	124	16	80	70	M26 x 1,5	16	32	8	46	-	-	M6 x 1,0	8	50	40	37	1/8"	8	39,5	
RMSP32	165	133	20,5	80		M26 x 1,5		32	8		36	-		-			8		41,5		10
RMSF32	270	238	48	110		M30 x 1,5		36	7		10	3,5		12,5			48		48		95
RMS40	182	150	22	92	70	M32 x 2,0	16	41	10	46	-	-	M6 x 1,0	9	60	40	45	1/4"	11	49,5	
RMSF40	327	295	44,5	130		M38 x 1,5		46	8		12	4,5	M8 x 1,25	16	50	56	122,5		25		

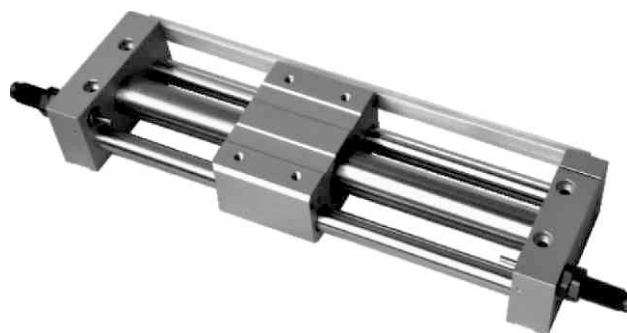

Como Ordenar su Cilindro - con guía

RMT 20 x 100 S □ T

① ② ③ ④ ⑤ ⑥

① Modelo : RMT, con guía

② Diámetro :
16 - 20 - 25 - 32 - 40

③ Carrera en mm

④ □ : Sin sensor magnético
S : Con sensor magnético

⑤ Amortiguación :
□ : Ajustable con tuerca
A : Con 2 absorbedores de choque

Ø 16 de 50 a 750 mm
Ø 20 de 50 a 1000 mm
Ø 25 de 50 a 1500 mm
Ø 32 de 50 a 1500 mm
Ø 40 de 50 a 1500 mm
Nota: Carrera Standar de 50 en 50 mm

⑥ T : NPT, conexión de entrada y salida

Especificaciones

Diámetro	16	20	25	32	40
Acción	Doble acción				
Fluido	Aire filtrado con elemento menor a 40 micras				
Presión de operación	36 - 100 PSI (2,5 - 7 Bar)				
Temperatura °C	-20°C a 70°C				
Rango de velocidad	50 - 400 mm/seg				
Tolerancia en carrera	De 0 a 250 mm = de 0 a 1 mm - De 251 a 1000 mm = de 0 a 1,5 mm - De 1001 mm en adelante = de 0 a 2 mm				
Tamaño de puerto	M5 x 0,8	1/8" NPT		1/4" NPT	
Fuerza de sujeción segura	14 Kg	22 Kg	34,5 Kg	56 Kg	88 Kg

Amortiguación

- Con Absorbedor de choque
Este viene ajustado de fabrica cuando se vaya a cambiar por desgaste hay que tener en cuenta el torque de apriete
- Ajustable con tuerca
Viene ajustado de fabrica

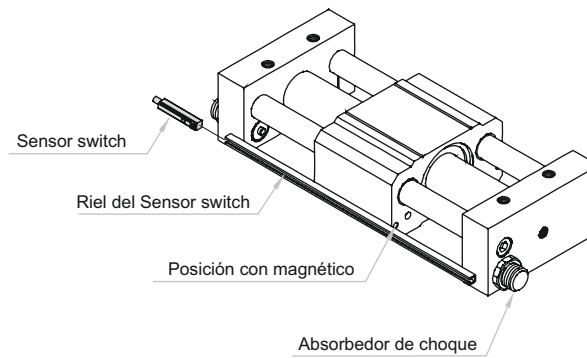

Modelo del cilindro	RMT16	RMT20	RMT25	RMT32	RMT40
Absorbedor de choque	ACA1006 - A	ACA1007 - 1N	ACA1412 - 1N	ACA2020 - 1N	ACA2020 - 1N
Torque de apriete	1,67 (Nm)	1,67 (Nm)	3,14 (Nm)	10,80 (Nm)	10,80 (Nm)
Sensor switch	CMSG / DMSG (S)				

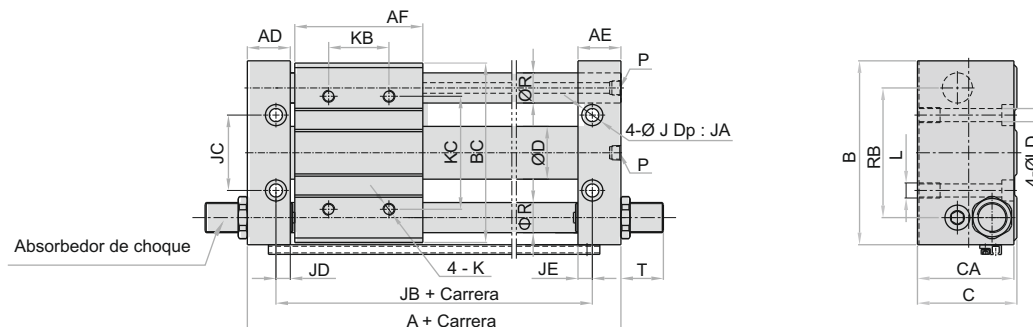

Unidades : mm

Diámetro	A	AD	AE	AF	B	BC	C	CA	D	J	JA	JB	JC	JD	JE
16	107	22,5	22,5	60	75	72	40	39	18	9,5	5	75	30	6,5	6,5
20	124	25,5	25,5	70	90	87	46	45	22,8	9,5	5	90	38	8,5	8,5
25	124	25,5	25,5	70	100	97	54	53	27,8	11	6,5	90	42	8,5	8,5
32	148	28,5	28,5	85	122	119	66	64	35	14	8	110	50	9,5	9,5
40	170	35,5	35,5	95	145	142	76	74	43	14	8	120	64	10,5	10,5

Diámetro	K	KB	KC	L	LD	P	R	RB	S	T
16	M5 x 0,8 Dp : 10	30	50	M6 x 1,0 Dp : 9,5	5,5	M5 x 0,8	12	52	15,5	8,5
20	M6 x 1,0 Dp : 10	40	70	M6 x 1,0 Dp : 9,5	5,5	1/8"	16	63	22,5	10,5
25	M6 x 1,0 Dp : 10	40	70	M8 x 1,25 Dp : 10	7	1/8"	16	70	40,5	11,5
32	M8 x 1,25 Dp : 12	40	75	M10 x 1,5 Dp : 15	8,5	1/8"	20	86	57,5	17,5
40	M8 x 1,25 Dp : 12	65	105	M10 x 1,5 Dp : 15	8,5	1/4"	25	105	50,5	10,5

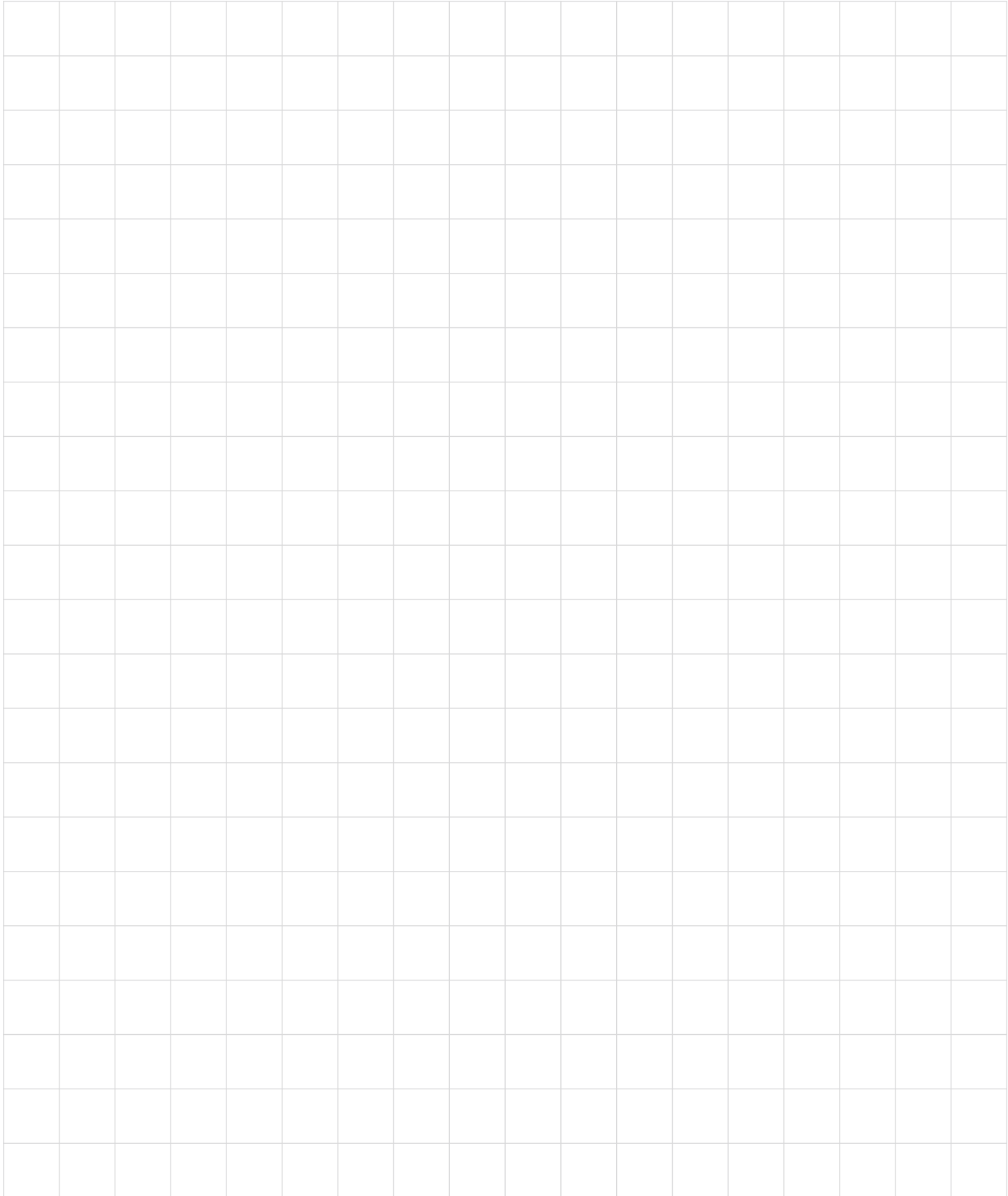

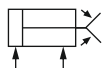

Características

- Ideales para sujetar piezas pequeñas en áreas difíciles
- Resistentes a la corrosión
- No necesitan lubricación
- Pinza de doble efecto
- Anillo magnético standard para control con autoswitches
- Varias opciones de montaje

Modelos Standard

Referencia	Diámetro	Conexión	Torque Teórico Cerrada	Torque Teórico Abierta	L Max.
CPA10	10 mm	M3	17,6 x P (N.cm)	29,4 x P (N.cm)	30 mm
CPA16	16 mm	M5	90 x P (N.cm)	129 x P (N.cm)	40 mm
CPA20	20 mm	M5	152 x P (N.cm)	252 x P (N.cm)	60 mm
CPA25	25 mm	M5	304 x P (N.cm)	473 x P (N.cm)	70 mm
CPA32	32 mm	M5	637 x P (N.cm)	904 x P (N.cm)	85 mm

Nota: P = Presión de trabajo
L = Máximo punto de pinzado

Recomendaciones para una manipulación segura con pinzas neumáticas

Datos Técnicos

Fluido:
Aire comprimido filtrado,
lubricado o no lubricado

Presión de Trabajo:
1 a 7 Bar ~ 14,5 a 101 PSI

Temperatura de Trabajo:
-20°C a 70°C ~ -4°F a 158°F

Frecuencia:
180 ciclos/min.

Desplazamiento:
-10° ~ +30°

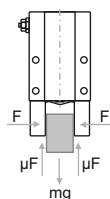

Escoja siempre una Fuerza de agarre de las pinzas que sea tantas veces mayor como seguridad quiera tener en el proceso

Calculo de la fuerza de agarre necesaria de la Pinza en función de:

La masa del objeto a manipular **m**
El coeficiente de rozamiento **μ** entre los dedos de la pinza y el objeto manipulado
La seguridad del proceso **a**

Ejemplo:

Para objetos con Rozamiento **μ = 0.2**
Con una seguridad del proceso **a = 4**
una masa **m**
y aceleración de la gravedad **g** (9.8 mt/s²)

La fuerza de agarre **F** de la pinza en Newtons:

$$F = \frac{mg}{2 \times 0.2} \times 4 = 10 \times mg$$

Es decir 10 veces la masa del objeto manipulado

Ejemplo:

Para objetos con Rozamiento **μ = 0.1**
Con una seguridad del proceso **a = 4**
una masa **m**
y aceleración de la gravedad **g** (9.8 mt/s²)

La fuerza de agarre **F** de la pinza en Newtons:

$$F = \frac{mg}{2 \times 0.1} \times 4 = 20 \times mg$$

Es decir 20 veces la masa del objeto manipulado

Materiales

Cuerpo : Aluminio Anodizado
Pinzas : Acero al Carbono

En Resumen:

La condición mínima para que un objeto manipulado no se caiga de las pinzas es: $F > \frac{mg}{2 \times \mu}$

Y la condición segura de agarre se da por: $F = \frac{mg}{2 \times \mu} \times a$

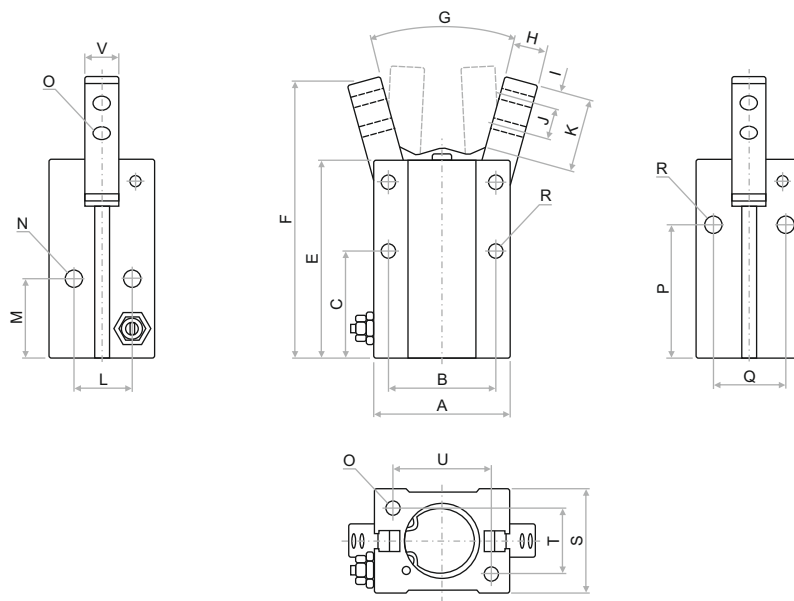

Diám.	A	B	C	E	F	G
10 mm	23	16	23	38.5	52.5	-10° ~ +30°
16 mm	30.5	24	24.5	44.5	62.5	-10° ~ +30°
20 mm	42	30	29	55	78	-10° ~ +30°
25 mm	52	36	30	60.5	92	-10° ~ +30°
32 mm	60	44	37.5	68	96.5	-10° ~ +30°

Diám.	H	I	J	K	L	M	N
10 mm	4	3	5.7	12	10	19	M3
16 mm	7	4	7	16	13	18.5	M5
20 mm	8	5	9	20	15	22	M5
25 mm	10	8	12	27	20	23.5	M5
32 mm	10	6	14	27	24	31	M5

Diám.	O	P	Q	R	S	T	U	V
10 mm	M2.5	27	11.5	M3	16.5	12	18	6.4
16 mm	M3	30	16	M4	23.5	15	22	8
20 mm	M4	35	18.6	M5	27.5	18	32	10
25 mm	M5	36.5	22	M6	33.5	22	40	12
32 mm	M6	30	26	M6	40	26	46	18

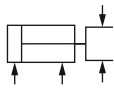

Características

- Ideales para sujetar piezas pequeñas en áreas difíciles
- Resistentes a la corrosión
- No necesitan lubricación
- Pinza de doble efecto
- Anillo magnético standard para control con autoswitches
- Varias opciones de montaje

Modelos Standard

Referencia	Diámetro	Conexión	Fuerza/pinzado Externo	Fuerza/pinzado Interno	Apertura
CPP16	16 mm	M5	34 N	45 N	6 mm
CPP20	20 mm	M5	45 N	68 N	10 mm
CPP25	25 mm	M5	69 N	102 N	14 mm
CPP32	32 mm	M5	160 N	195 N	22 mm
CPP40	40 mm	M5	255 N	320 N	30 mm

Recomendaciones para una manipulación segura con pinzas neumáticas

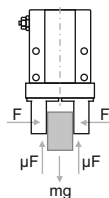

Escoja siempre una Fuerza de agarre de las pinzas que sea tantas veces mayor como seguridad quiera tener en el proceso

Calculo de la fuerza de agarre necesaria de la Pinza en función de:

La masa del objeto a manipular **m**
 El coeficiente de rozamiento **μ** entre los dedos de la pinza y el objeto manipulado
 La seguridad del proceso **a**

Datos Técnicos

Fluido:
 Aire comprimido filtrado,
 lubricado o no lubricado

Presión de Trabajo:
 1 a 7 Bar ~ 14,5 a 101 PSI

Temperatura de Trabajo:
 -20°C a 70°C ~ -4°F a 158°F

Frecuencia:
 Ø16 ~ 25: 180 ciclos/min.
 Ø32 y 40: 60 ciclos/min.

Ejemplo:

Para objetos con Rozamiento $\mu = 0.2$
 Con una seguridad del proceso $a = 4$
 una masa **m**
 y aceleración de la gravedad **g** (9.8 mt/s²)

La fuerza de agarre **F** de la pinza en Newtons:

$$F = \frac{mg}{2 \times 0.2} \times 4 = 10 \times mg$$

Es decir 10 veces la masa del objeto manipulado

Ejemplo:

Para objetos con Rozamiento $\mu = 0.1$
 Con una seguridad del proceso $a = 4$
 una masa **m**
 y aceleración de la gravedad **g** (9.8 mt/s²)

La fuerza de agarre **F** de la pinza en Newtons:

$$F = \frac{mg}{2 \times 0.1} \times 4 = 20 \times mg$$

Es decir 20 veces la masa del objeto manipulado

Materiales

Cuerpo : Aluminio Anodizado
 Pinzas : Acero Inoxidable

En Resumen:

La condición mínima para que un objeto manipulado no se caiga de las pinzas es: $F > \frac{mg}{2 \times \mu}$

Y la condición segura de agarre se da por: $F = \frac{mg}{2 \times \mu} \times a$

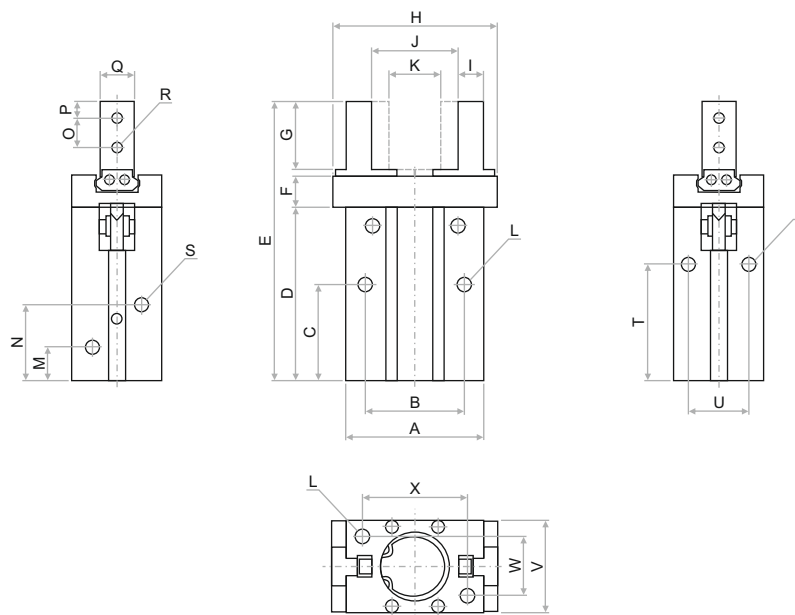

Diám.	A	B	C	D	E	F	G	H
16 mm	30.6	24	24.5	42.5	67.3	7.5	15	38
20 mm	42	30	29	52.8	84.7	9.5	20	50
25 mm	52	36	30	63.6	102.7	11	25	63
32 mm	60	46	40	67	113	12	29	97
40 mm	72	56	49	83	139	15	36	119

Diám.	I	J	K	L	M	N	O	P
16 mm	5	20.9	14.9	M4	7.5	19	7	4
20 mm	8	26.3	16.3	M5	9.7	23	9	5
25 mm	10	33.3	19.3	M6	10	23.8	12	6
32 mm	12	48	26	M6	11	31	14	7
40 mm	14	60	30	M8	12	38	17	9

Diám.	Q	R	S	T	U	V	W	X
16 mm	8	M3	M5	30	16	23.6	15	22
20 mm	10	M4	M5	35	18.6	27.6	18	32
25 mm	12	M5	M5	36.5	22	33.6	22	40
32 mm	15	M6	M5	48	26	40	26	46
40 mm	18	M8	M5	58	32	48	32	56

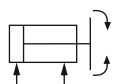

Características

- Ideales para sujetar piezas pequeñas en áreas difíciles
- Resistentes a la corrosión
- No necesitan lubricación
- Pinza de doble efecto
- Anillo magnético standard para control con autoswitches
- Varias opciones de montaje

Modelos Standard

Referencia	Diámetro	Conexión	Torque Teórico	Max. Longitud de Agarre
CPO16	16 mm	M5	0,55 Nm	15 mm
CPO20	20 mm	M5	1,10 Nm	20 mm
CPO25	25 mm	M5	2,30 Nm	24 mm
CPO32	32 mm	M5	5,20 Nm	36,8 mm

Como seleccionar la pinza:

Seleccione la fuerza efectiva de la pinza 10 o 20 veces más grande que el peso de la pieza a levantar.

Tenga en cuenta la distancia del punto de pinzado, según el diagrama la distancia: **L**

Ejemplo: Pieza a levantar: 0.05 Kg.
 Distancia de pinzado **L**: 30mm
 Aceleración de la gravedad: 9.8 mt/s²
 Presión de operación: 5 Bar

- $0.05\text{kg} \times 20 \text{ veces} \times 9.8 \text{ mt/s}^2 = 9.8\text{N}$
 - De acuerdo con la tabla inferior la pinza a utilizar es la de Ø 16mm

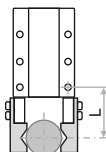

Datos Técnicos

Fluido:
 Aire comprimido filtrado,
 lubricado o no lubricado

Presión de Trabajo:
 1 a 7 Bar ~ 14,5 a 101 PSI

Temperatura de Trabajo:
 -10°C a 70°C ~ 14°F a 158°F

Frecuencia:
 60 ciclos/min.

Desplazamiento:
 180° ± 2°

Fuerza efectiva entre la fuerza de pinzado y la distancia:

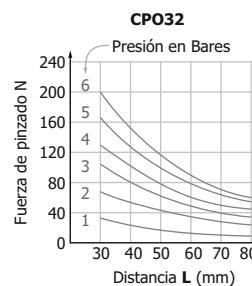
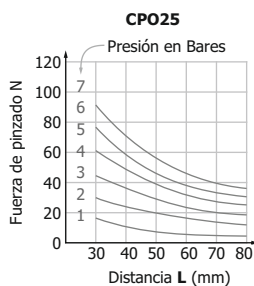
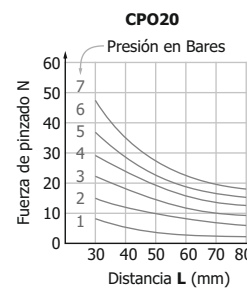
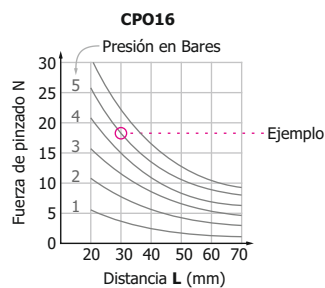

Materiales

Cuerpo : Aluminio Anodizado
 Pinzas : Acero Inoxidable

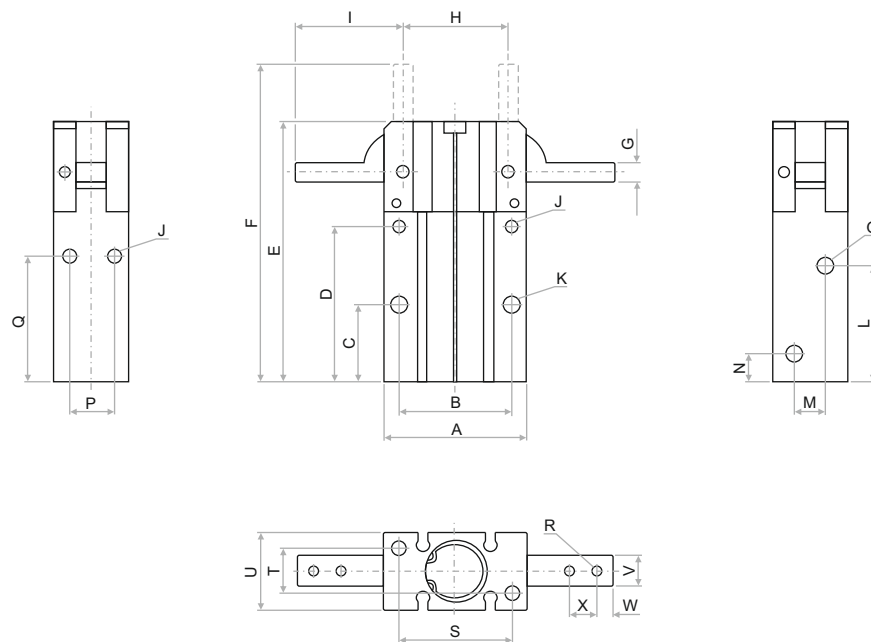

Diám.	A	B	C	D	E	F	G	H
16 mm	38	30	20	41	69	84	5	28
20 mm	48	36	25	50	86	106	8	36
25 mm	58	42	30	60	107	131	10	45
32 mm	72	46	35	64	122	158,5	12	55

Diám.	I	J	ØK	L	M	N	O	P
16 mm	28,5	M4 x 0.7	4,5	30,5	8	7	M5 x 0.8	12
20 mm	37	M5 x 0.8	5,5	38,5	12	8	M5 x 0.8	14
25 mm	45	M6 x 1.0	6,5	48	14	8	M5 x 0.8	16
32 mm	62,5	M6 x 1.0	6,5	56	18	9	M5 x 0.8	26

Diám.	Q	R	S	T	U	V	W	X
16 mm	33	M3 x 0.5	30	12	20	8	4	7
20 mm	42	M4 x 0.7	38	16	26	10	5	9
25 mm	50	M5 x 0.8	46	18	30	12	6	12
32 mm	59	M6 x 1.0	46	26	40	14	9	16

Autoswitch

Tipo Red Switch con LED (2 hilos)



Referencia	Usar con
CUSS01	CPA / CPP
CRMS01	CPP / CPO

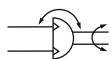

Características

- Diseño de piñón cremallera
- Alta precisión de la plataforma de trabajo
- La plataforma de trabajo posee un orificio central que facilita el montaje
- Orientación muy precisa
- Poseen amortiguador de choque interno
- Anillo magnético standard para control con autoswitches

Modelos Standard

Referencia	Conexión	Torque a 75 PSI	Máx. Absorción de Energía	Tiempo de rotación (90°)
CRM30	1/8"	2.75 N.m	0.12 N.m	0.2 ~ 0.7 seg.
CRM50	1/8"	5.15 N.m	0.30 N.m	0.2 ~ 0.7 seg.
CRM70	1/8"	7.5 N.m	1.1 N.m	0.2 ~ 1.0 seg.

Máxima Carga Permitida

Referencia	Radial	Axial	Flexión
CRM30	20,4 kgf (200 N)	20,4 kgf (200 N)	0,55 kgf-m (5,5 Nm)
CRM50	30,6 kgf (300 N)	30,6 kgf (300 N)	1,0 kgf-m (10 Nm)
CRM70	33,7 kgf (330 N)	30,6 kgf (300 N)	1,2 kgf-m (12 Nm)

Datos Técnicos

Fluido:
Aire comprimido filtrado

Presión de Trabajo:
1 a 6 Bar ~ 14,5 a 87 PSI

Temperatura de Trabajo:
0°C a 60°C ~ 32°F a 140°F

Angulo de Rotación:
0° ~ 190°

Materiales

Cuerpo : Aluminio Anodizado
Sellos : NBR

Instalación

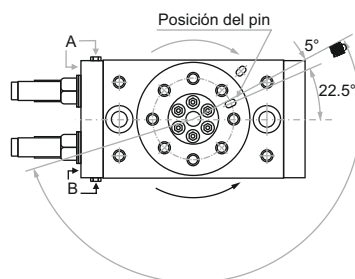

Dirección de Rotación

La mesa gira a la derecha cuando se presuriza por el puerto A.

La mesa gira a la izquierda cuando se presuriza por el puerto B.

Ajustando A

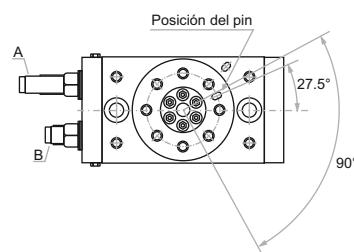

Ajustando B

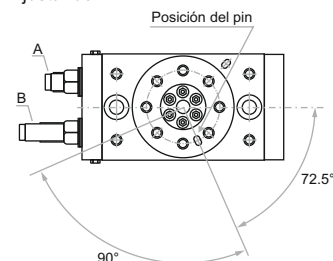

Ajustando A y B

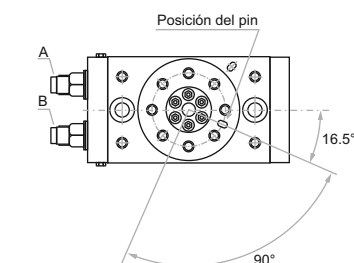

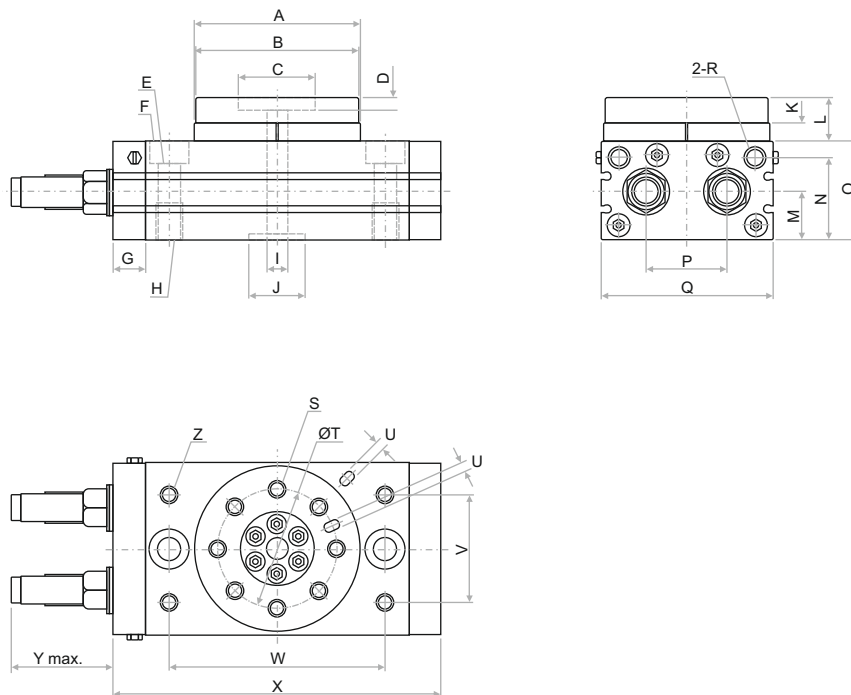

Referencia	A	B	C	D	E	F	G	H	I
CRM30	67	65	32	5	8.5	14	11.5	M10x1.5	9
CRM50	77	75	35	5.5	10.5	18	15	M12x1.75	10
CRM70	90	88	46	5	10.5	17.5	17	M12x1.75	16

Referencia	J	K	L	M	N	O	P	Q	R
CRM30	22	10	17	18.5	32	40	29	70	1/8"
CRM50	26	12	20	22	38	46	38	80	1/8"
CRM70	22	12.5	22	25.5	44.5	53	42	88	1/8"

Referencia	S	T	U	V	W	X	Y	Z
CRM30	M6 x 1.0	48	4	37	84	127	38.4	M6 x 1.0
CRM50	M8 x 1.25	55	5	50	100	152	51	M8 x 1.25
CRM70	M8 x 1.25	67	5	57	110	170	68	M8 x 1.25

Autoswitch



Referencia
CRMS01

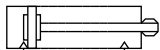

Características

- Diseñados especialmente para frenar elementos en una banda transportadora
- Poseen amortiguador de choque interno para una máxima absorción de energía
- Bloqueo de seguridad que previene el retorno del cilindro
- Anillo magnético standard para control con autoswitches

Modelos Standard

Referencia	Conexión	Diámetro	Carrera
CF3220	1/8"	32 mm	20 mm
CF4030	1/8"	40 mm	30 mm
CF5030	1/8"	50 mm	30 mm
CF6330	1/4"	63 mm	30 mm

Datos Técnicos

Fluido:

Aire comprimido filtrado

Presión de Trabajo:

1.5 a 10 Bar ~ 23 a 145 PSI

Temperatura de Trabajo:

-20°C a 80°C ~ -4°F a 176°F

Montaje:

Flanche

Secuencia

Posición original del rodillo

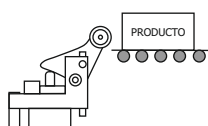

Bloqueo del rodillo

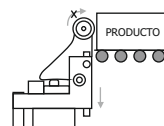

Desbloqueo del rodillo

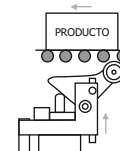

Materiales

Perfil:

Aluminio inyectado

Vástago:

Acero al carbón con 20µ de superficie cromo-endurecida

Silenciador:

Bronce

Empaques:

TPU (Poliuretano Termoplástico)
NBR

Cómo seleccionar el cilindro

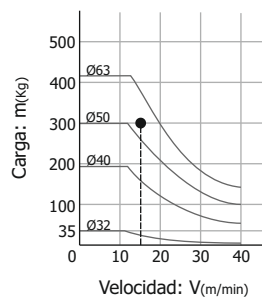

Ejemplo:

Con una carga de 300 Kg.
Velocidad de 15 m/min.
Factor de fricción de 0.1

Al trazar una línea vertical sobre el eje X en 15 m/min.
Y una línea horizontal sobre el eje Y en 300 Kg.
El punto de unión nos indica que debemos utilizar el cilindro de Ø 63 mm.

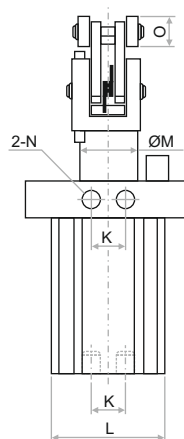
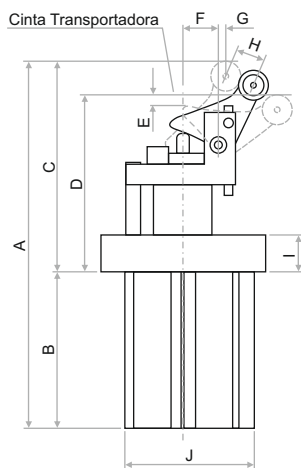
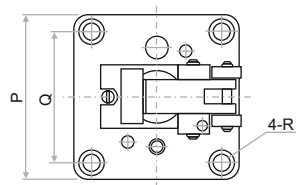

Referencia	A	B	C	D	E	F	G	H	I
CF3220	152.5	65.5	87	73.4	1.7	12	3.5	28	16
CF4030	191	79	112	92.3	3.7	16	5	26	16
CF5030	211	83	128	107.4	2.2	21	5	24	20
CF6330	245.5	101	144.5	122	3.2	25	5	24	25

Referencia	J	K	L	M	N	O	P	Q	R
CF3220	51.5	16	46	20	1/8"	12	67	53	6.6
CF4030	62	16	53	25	1/8"	20	82	65	6.6
CF5030	72	18	64	32	1/8"	20	93	73	9
CF6330	87.5	24	77	40	1/4"	20	114	90	11

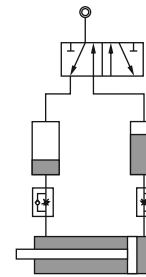
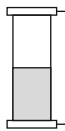

Características

- Depósito de aceite para el manejo de cilindros a muy baja velocidad de avance, con movimiento continuo.
- El sistema hidro-neumático combina la velocidad y el bajo costo del aire comprimido con la precisión del movimiento hidráulico
- Aplicación en herramientas automatizadas
- Indicador de nivel visual

Cómo ordenar su tanque hidro-neumático:

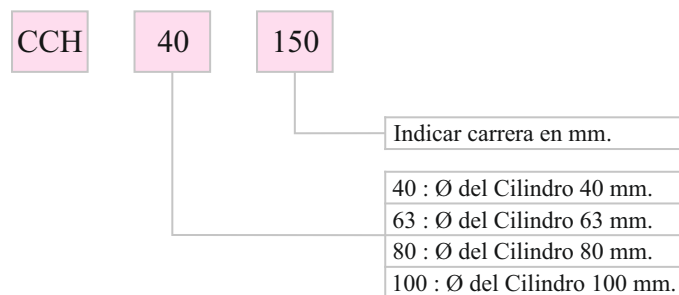

Volumen del tanque (cm³)

Ø	Carrera del cilindro en mm.										
	25	50	75	100	125	150	200	250	300	350	400
40	31.4	62.8	94.2	125.6	157	88.4	251.2	314	376.8	439.6	502.4
63	62	156	238	311.7	390	468	623	780	935	1091	1247
80	125	251	377	502	628	753	1005	1256	1507	1759	2010
100	196	293	589	785	981	1178	1570	1962	-	-	-

Datos Técnicos

Fluido:
Aceite VG32

Máx. Presión de Trabajo:
10.5 Bar ~ 152 PSI

Temperatura de Trabajo:
-10°C a 60°C ~ 14°F a 140°F

Montaje:
Flanche Posterior

Materiales

Cabezas : Aluminio
Camisa : Aluminio
Sellos : NBR

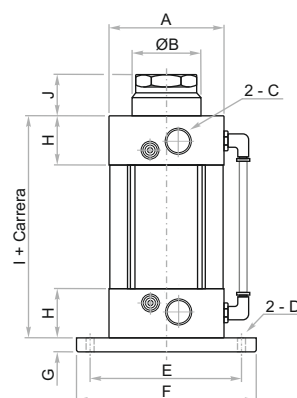

Ø	40	63	80	100
A	54	75	95.25	110
B	35	45	38.1	55
C	1/4"	3/8"	1/2"	1/2"
D	9	9	11.1	14.5
E	72	100	119	150
F	90	120	139.7	178
G	10	12	15.9	16
H	32	33	39.9	37
I	105	121	108	138
J	30	37	44	51

MULTIPLICADOR DE PRESION PARA CILINDRO HIDRAULICO

SERIE CMH

Art

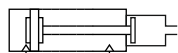

Características

- Incrementa la presión hasta un máximo de 11 veces, en un cilindro hidráulico
- Diseño compacto que ahorra espacio y energía
- Eficiente vía de generar alta presión de un fluido hidráulico

Modelos Standard

Referencia	Conexión	Máx.. Frecuencia	Peso
CMH04	G 1/2"	6 veces/min	9.1 Kg.

El multiplicador se vende sin el cilindro hidráulico.

Modo de operación

Datos Técnicos

Fluido:
Aire comprimido y aceite

Presión de Trabajo:
2 a 7 Bar ~ 29 a 101 PSI

Relación de Presión:
Máximo 1 : 11

Temperatura de Trabajo:
5°C a 60°C ~ 41°F a 140°F

Volumen de Descarga:
120 cc

Montaje:
De pies

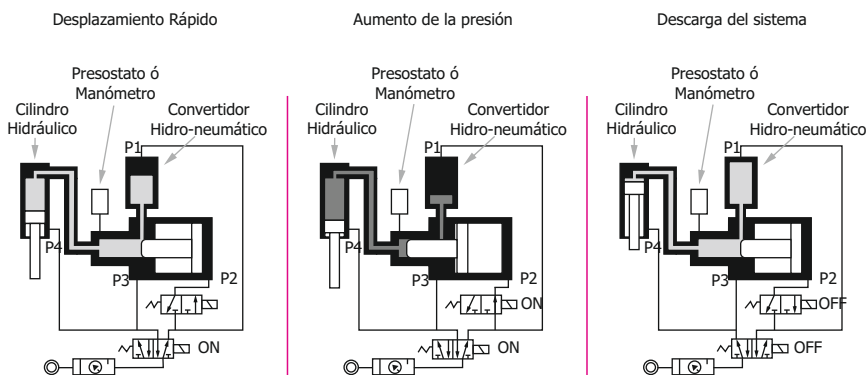

Materiales

Cabezas : Aluminio
Camisa : Aluminio
Sellos : NBR

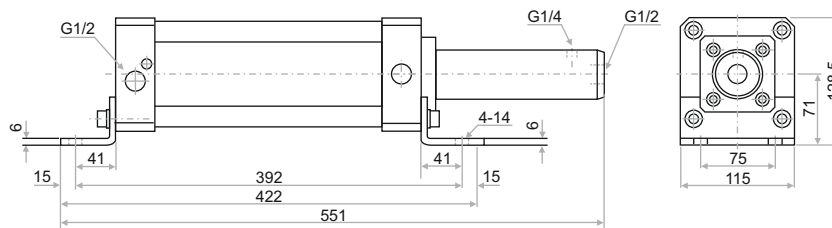

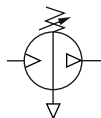

Características

- Incrementa la presión de alimentación, máximo:
CMP02 : Cuatro veces
CMP03 : Dos veces
PMP04 : Dos veces
- Ajuste sencillo mediante perilla
- Funcionamiento totalmente neumático y bajo nivel de ruido

Modelos Standard

Referencia	NPT	Flujo Máximo	Usar Tanque de:
CMP02	1/4"	70 lt/min	10 Litros
CMP03	3/8"	1.000 lt/min	20 Litros
CMP04	1/2"	1.900 lt/min	38 Litros

El multiplicador se vende sin el tanque de almacenamiento.

Datos Técnicos

Fluido:
Aire comprimido, no requiere de aceite

Presión de Trabajo:
2 a 10 Bar ~ 29 a 145 PSI

Relación de Presión:
Máximo 1 : 4 y 1 : 2

Temperatura de Trabajo:
2°C a 50°C ~ 36°F a 122°F

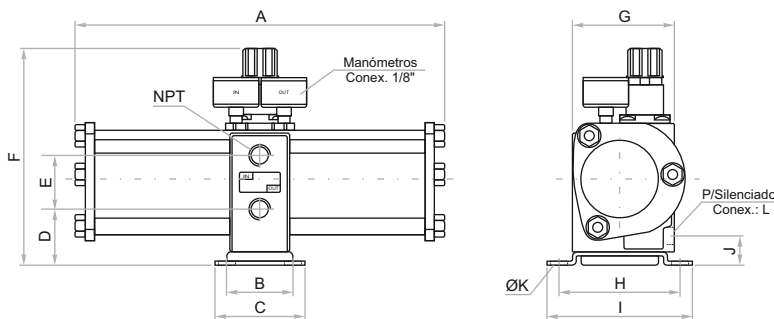

NPT	A	B	C	D	E	F
1/4"	150	40	50	27	23	113
3/8"	300	53	73	46	43	176
1/2"	404	96	116	62,8	62	215

Materiales

Cuerpo : Aluminio
Tanque : Acero al Carbón
Sellos : NBR

NPT	G	H	I	J	ØK	L
1/4"	50	60	70	22	5,5	1/4
3/8"	82	98	18	24	12	3/8
1/2"	118	130	150	32	12	1/2

CILINDRO POSICIONADOR LINEAL

SERIE CP

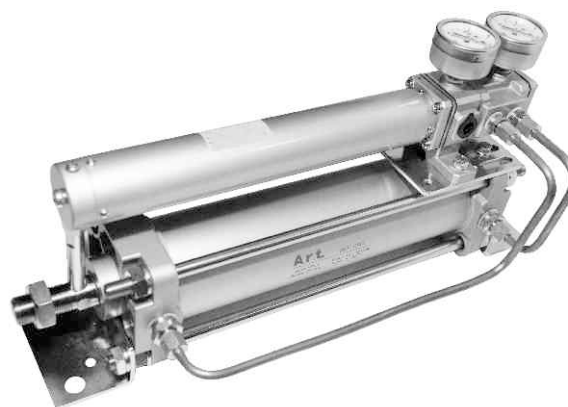
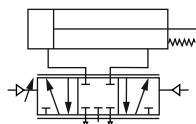
Art**Características**

- Norma ISO-CETOP
- Permite el posicionamiento más exacto de un cilindro
- 99% de exactitud de repetitividad
- La carrera del cilindro es proporcional a la gama de señales de control entre 0.2 y 1 Bar
- Ideal para posicionamiento a distancia o regulación de carreras en unidades de dosificación, bombas, engranajes, velocidades, apertura proporcional de válvulas, etc.

Modelo Standard

Referencia	Diámetro	Carrera	Conexión	Control
CP63	63 mm	200 mm	3/8"	Neumático

El control neumático se realiza mediante un regulador de presión que no se suministra con el posicionador

Materiales

Cuerpo:
Aluminio

Cabezas:
Aluminio Anodizado

Vástago:
Acero Inoxidable

Control:
Aluminio y Acero Inoxidable

Empaques:
Goma Nitrílica

Datos Técnicos

Fluido:
Aire comprimido Filtrado, sin lubricar

Linealidad:
Menor del 2%

Presión de Trabajo:
1 a 7 Bar ~ 15 a 100 PSI

Histéresis:
Menor del 1%

Presión de la Señal:
0,2 a 1 Bar ~ 3 a 15 PSI

Sensibilidad:
Menor del 1% de la escala

Temperatura de Trabajo:
-5°C a 60°C ~ 23°F a 140°F

Exactitud de Repetición:
Menor del 1%

Consumo de Aire:
18 NI/min ~ 0,64 SCFM

Montaje:
Pies

CILINDRO POSICIONADOR LINEAL

SERIE CP

Ar.t

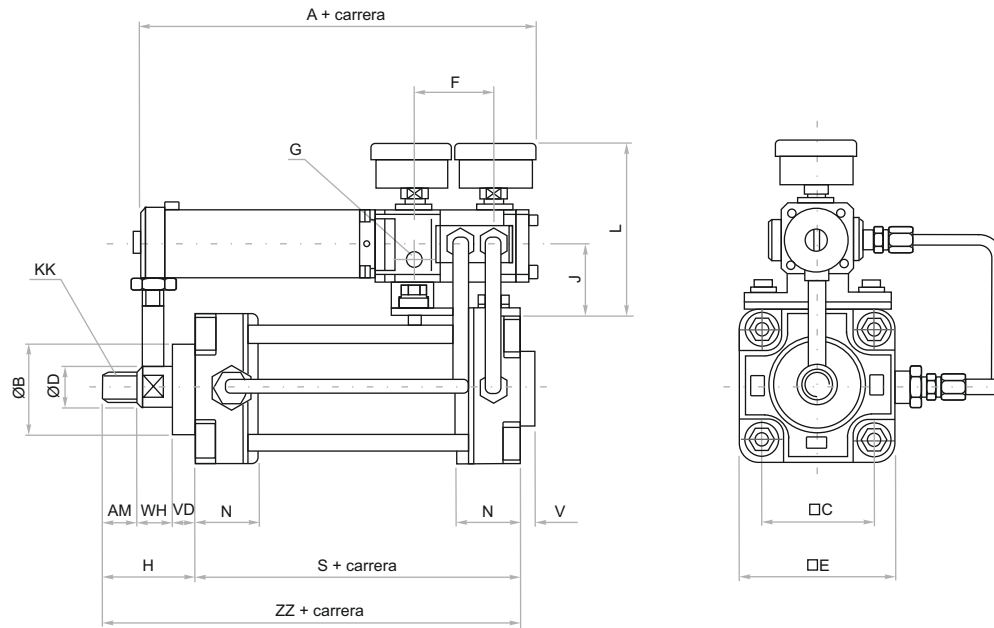

Díámetro	A	AM	ØB	C	ØD	E
63 mm	135	32	40	64	20	85

Díámetro	F	G	H	J	KK	L
63 mm	35	1/4 G	80,5	40	M16 x 1,5	100

Díámetro	N	S	V	VD	WH	ZZ
63 mm	31	98	6	10	48,5	184,5

Prensas neumáticas ampliamente utilizadas en talleres de metalmecánica o plantas manufactureras que necesiten realizar trabajos en serie de sujeción, estampado, repujado, punzonado, corte, troquelado o cualquier otra labor que requiera una fuerza proporcional al tamaño del cilindro que la compone.

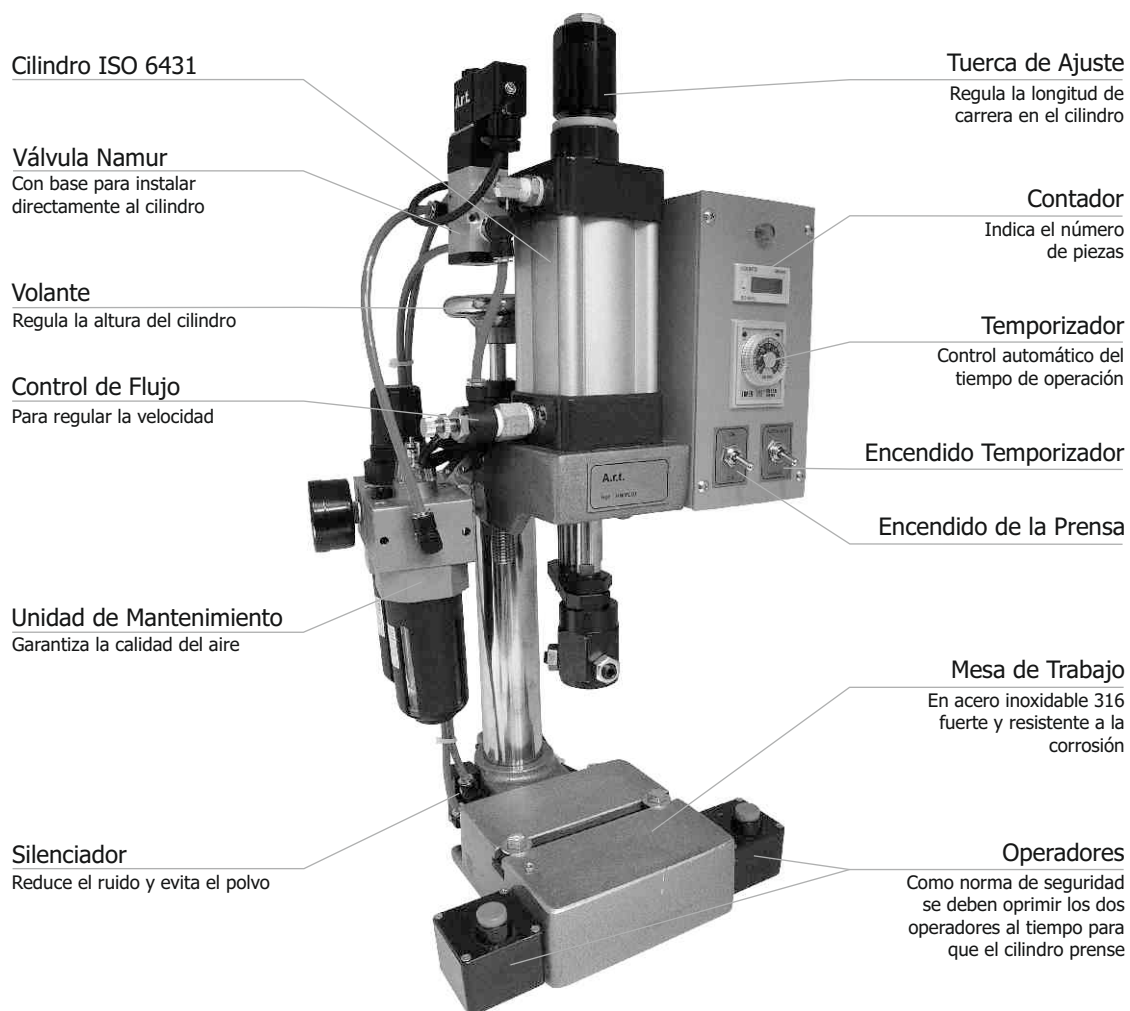

Características

- Doble control manual para mayor seguridad
- Temporizador electrónico y contador de piezas
- Permite instalar un escape rápido para mayor velocidad
- Cilindro con guía antigiro



Prensas Neumáticas

Referencia	Conexión	Ø Cilindro	Carrera	Fuerza a 100 PSI
PN05050	1/4"	50 mm	50 mm	302 lbs.
PN06350	1/4"	63 mm	50 mm	480 lbs.
PN080100	3/8"	80 mm	100 mm	700 lbs.
PN100100	3/8"	100 mm	100 mm	1.136 lbs.

Datos Técnicos

Fluido:
Aire comprimido

Presión de Trabajo:
1.5 a 10 Bar ~ 21 a 145 PSI

Temperatura de Trabajo:
-10°C a 60°C ~ 14°F a 140°F

Fuerzas Teóricas de Prensado

Presión de Operación		PN05050		PN06350	
Bar	PSI	N	Lb	N	Lb
4	57	774	174	1.255	275
5	71	960	216	1.523	344
6	85	1.156	260	1.833	412
7	100	1.343	302	2.136	480

Materiales

Estructura : Acero
Mesa : Acero Inox. 316
Cilindro : Aluminio

Presión de Operación		PN080100		PN100100	
Bar	PSI	N	Lb	N	Lb
4	57	1.775	400	2.883	649
5	71	2.226	500	3.609	811
6	85	2.668	600	4.335	974
7	100	3.109	700	5.051	1.136

PN05050 - PN06350

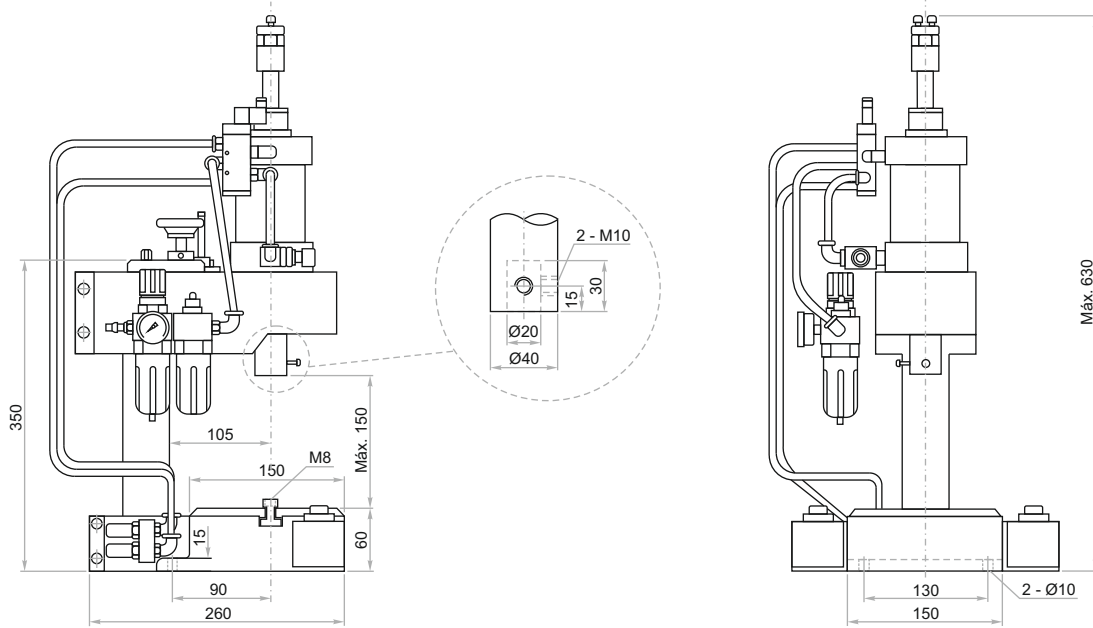

PN080100 - PN100100

